



SASHA™
DAW

INSTALLATION AND CARE GUIDE

CONTENTS

SECTION 1—WASP SETUP	7
SECTION 1.1 —SASHA DAW CRATE CONTENT	8
SECTION 1.2—WASP	9
ZONE OF NEUTRALITY: LEFT AND RIGHT CHANNEL	10
SPEAKER PLACEMENT VERSUS LISTENING POSITION	14
SPEAKER ORIENTATION	14
SECTION 2—SASHA DAW ASSEMBLY	19
SECTION 2.1—UNCRATING THE SASHA DAW.....	20
INITIAL CHECK	20
UNCRATING THE WOOFER MODULE	20
UNCRATING THE UPPER MODULE	21
SECTION 2.2—CRATE CONTENT CHECKLIST.....	22
SECTION 2.3—INITIAL ASSEMBLY	24
PREPARATION	24
.....	24
UPPER MODULE ASSEMBLY.....	24
ALIGNMENT PROCEDURE	25

Wilson Audio® is a registered trademark of Wilson Audio Specialties, Inc.

Sophia®, Sasha DAW®, Sasha DAW, Subsonic, WAMM®, MAXX®, XLF®, and Alexandria® are registered trademarks of Wilson Audio Specialties, Inc.

Alexx™, Sabrina™, Alida™, Alexia™, WilsonGloss™, Wilson Audio Duet™, WATCH Center™, WATCH Surround™, WATCH Dog™, and Thor's Hammer™ are trademarks of Wilson Audio Specialties, Inc.

This manual was produced by the Wilson Audio Engineering and the Sales and Marketing Department. The information contained herein is subject to change without notice. Current Revision 1.1. If you are in need of a more recent manual, please contact your dealer or download one at www.wilsonaudio.com.

The information in this manual is the sole property of Wilson Audio Specialties, Inc. Any reproduction, in whole or in part, without the express written permission of Wilson Audio Specialties, Inc., is prohibited. No material contained herein may be transmitted in any form or by any means, electronic or mechanical, for any purpose, without the express written permission of Wilson Audio Specialties, Inc.

Copyright © 2018 Wilson Audio Specialties

4 SASHA DAW INSTALLATION AND CARE GUIDE

SECTION 2.4—MOUNTING THE UPPER MODULE	27
MATERIALS REQUIRED:.....	27
INSTALL THE UPPER MODULE AS FOLLOWS:	28
UMBILICAL CONNECTIONS.....	29
SECTION 3—FINAL SETUP	31
SECTION 3.1 – SPIKING THE SASHA DAW.....	32
WOOFER MODULE SPIKES	32
SPIKE/DIODE ASSEMBLY.....	32
SPIKE INSTALLATION PROCEDURE.....	33
SECTION 3.3—REMOVING THE PROTECTIVE FILM.....	35
SECTION 3.4—RESISTORS	36
MIDRANGE AND TWEETER RESISTORS.....	36
WOOFER DAMPING RESISTOR.....	37
SECTION 4—SPECIFICATIONS	39
SECTION 4.1—SPECIFICATIONS:.....	40
SECTION 4.2—GRAPHICAL DIMENSIONS:	41
SECTION 5—TIME-ALIGNMENT CHARTS	43
SECTION 5—PROPAGATION DELAY NOMOGRAPHS	44

5

TIME ALIGNMENT CHARTS	44
SECTION 6—WARRANTY	47
SECTION 6—WARRANTY DETAILS	48
LIMITED WARRANTY	48
CONDITIONS	48
REMEDY.....	49
WARRANTY LIMITED TO ORIGINAL PURCHASER	50
DEMONSTRATION EQUIPMENT	50
MISCELLANEOUS.....	51



SECTION 1—WASP SETUP

Section 1.1 –Sasha DAW Crate Content

Please take the time before you attempt to setup up your Sasha DAW to review the contents of your Sasha DAW tool and spike kit. Set these items in an accessible area as you will need them during the setup process. See the two graphics below:

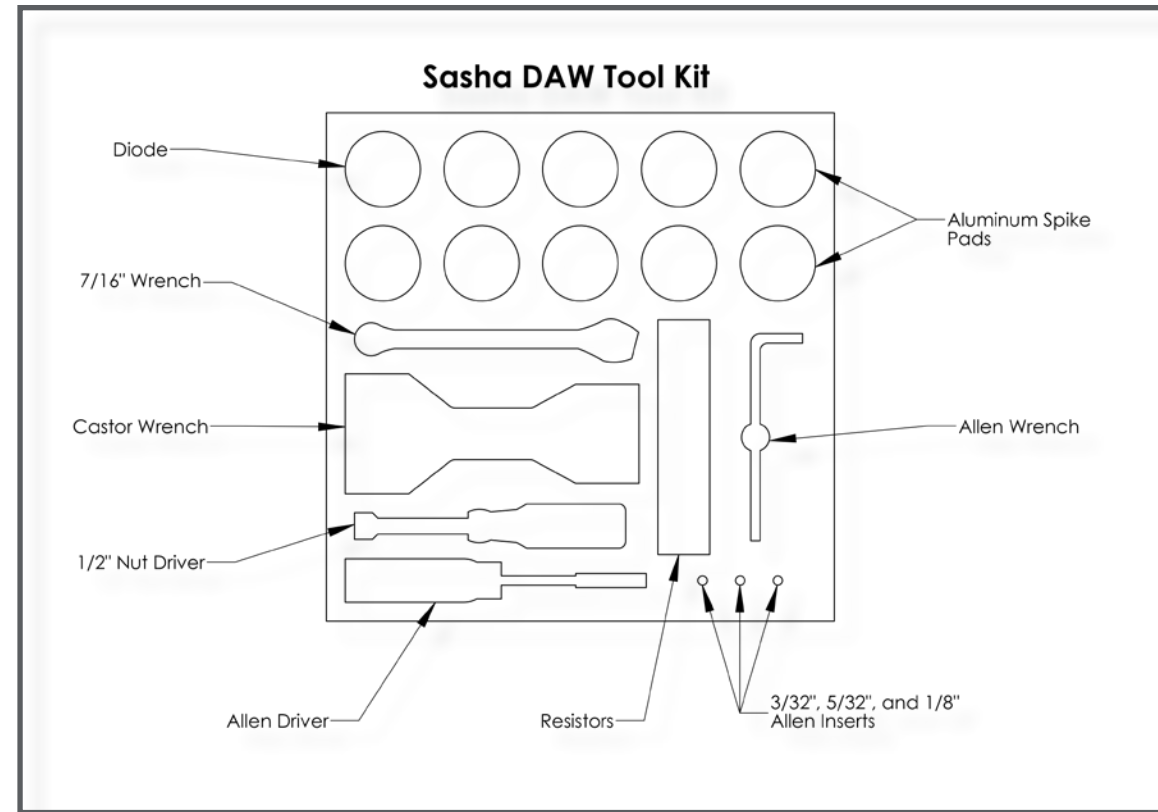

Section 1.2—WASP

An instructional video outlining the Wilson Audio Setup Procedure (WASP) can be found here: www.wilsonaudio.com/WASP. The proper positioning of your new Sasha DAW within your room is critical in order to extract its formidable performance envelope. When carefully followed, the WASP has proven to be the

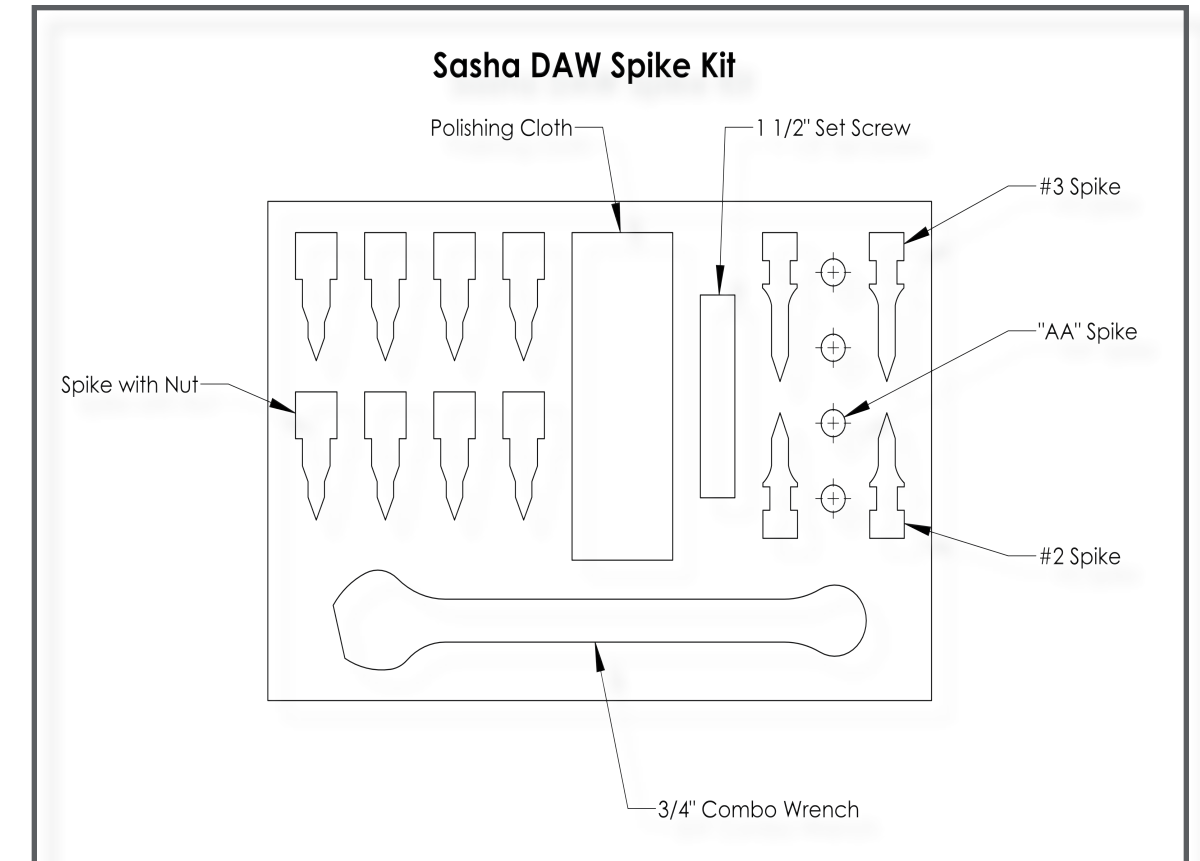

most effective method for setting up Wilson loudspeakers. Your authorized Wilson dealer is trained in this process, and is the best resource for you to ensure your loudspeakers are set up properly.

Viewing the video is the best way to learn how to properly employ WASP, but we have also included an outline of it here.

Zone of Neutrality: Left and Right Channel

The “Zone of Neutrality” is an area in your room where the speakers will sound most natural. This location is where the speakers interact the least with adjacent room boundaries. It is important to have a clear working space while determining the Zone of Neutrality.

The following is a simple method to locate the Zone of Neutrality within your listening environment:

1. Stand against the wall BEHIND the location where you intend to position your loudspeakers. Speaking in a moderately loud voice and at a constant volume, project your voice out into the room. Your voice will have an overly heavy, “chesty” quality because of your proximity to the rear wall.
2. While speaking, slowly move out into the room, progressing in a direction parallel to the sidewall. It is helpful to have another listener seated in the listening position to assist you during this process. Listen to how your voice “frees up” from the added

bass energy imparted by the rear wall boundary. Also notice that your voice is quite spatially diffuse (to your assistant, your voice will sound spatially large and difficult to localize) as you begin to ease away from the rear wall.

3. At some point during your progression forward into the room, you will observe a sonic transition in your voice; it will sound more tonally correct and less spatially diffuse (your assistant can now precisely localize the exact origin of your voice). When you hear this transition, you have entered the inner edge of the Zone of Neutrality. Place a piece of tape on the floor to mark this location. Although it will vary from room to room, in most rooms the zone begins between two and a half to three feet from the rear wall.
4. Continue to walk slowly away from the rear wall. After some distance, usually one to two feet past the first piece of tape, you will begin to hear your voice lose focus and appear to reflect (echo) in front of you. This is caused by the return of the room’s boundary contribution; your voice is now interacting with the opposite wall. At the point where you begin to hear the reflected sound of your voice, you have reached the outer edge of the Zone of Neutrality. Place a piece of tape on the floor and mark this location. The distance between the “inner”

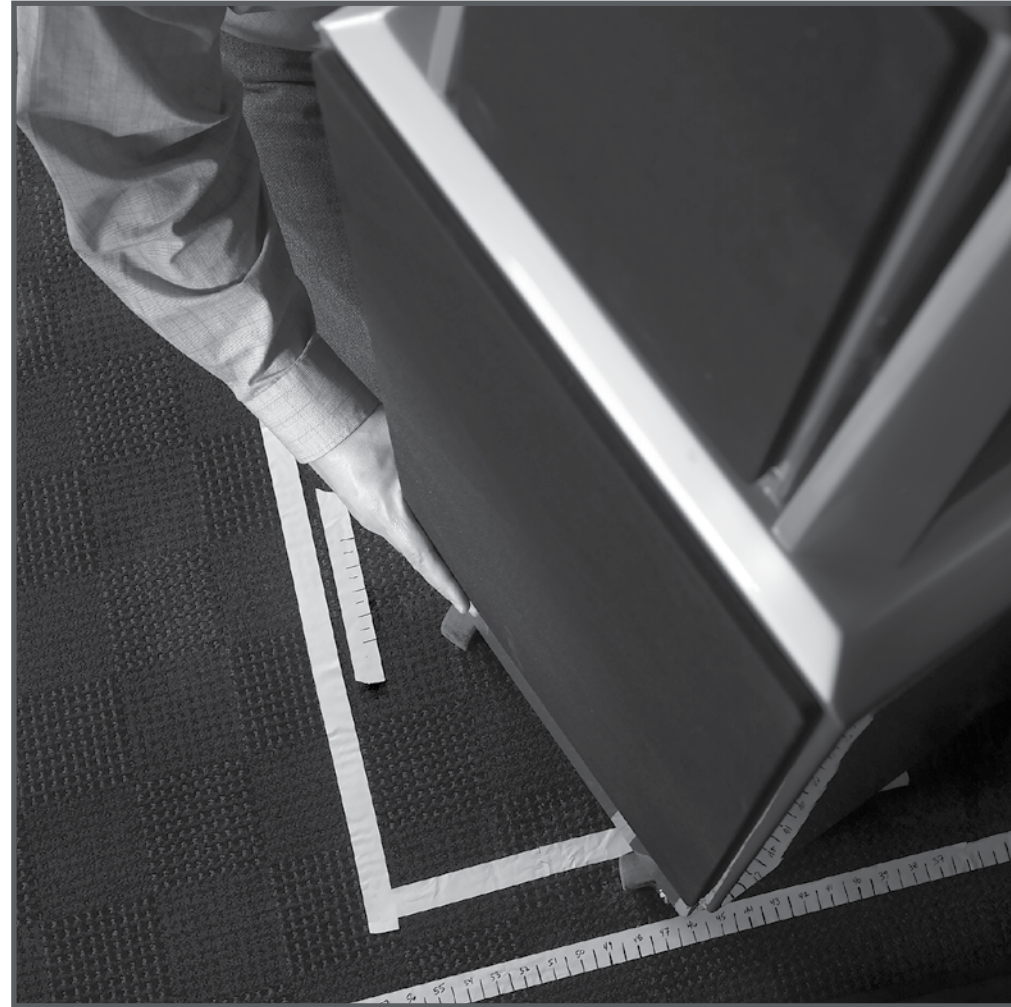

When carefully followed, the WASP has proven to be the most effective method for setting up Wilson loudspeakers.

and “outer” edge tape marks is usually between eight inches (for small, interactive rooms) and three feet (for large, more neutral rooms).

5. Now position yourself against the side wall perpendicular to the intended speaker location. Stand between the two tape marks. Using the same procedure as above, begin moving into the room toward the opposite sidewall, progressing between the two pieces of tape. As above, listen for the point in the room where your voice transitions from bass-heavy and diffuse to neutral. Mark this point with tape. Continue your progression until there is an obvious interaction with the opposite wall in front of you and mark this point with tape. The four pieces of tape now form a rectangle that establishes the Zone of Neutrality for the loudspeaker to be installed on that side of the room. Using the four marks as your guide, tape an outline to define the boundaries of the rectangle.
6. Repeat this process for each speaker location individually. These are your Zones of Neutrality, one for each channel.

Theoretically, the Zone of Neutrality for any room runs like a path, parallel to the walls all around the room. Adjacent to very large windows and open doors, the outer edge of the Zone of Neutrality moves closer to the wall and be-

comes wider. If you were to extend the inner and outer boundaries of the Zone for the sidewalls and the front wall (behind the speakers), they would intersect.

Speaker Placement Versus Listening Position

The location of your listening position is as important as the careful setup of your Wilson Audio loudspeakers. The listening position should ideally be no more than 1.1 to 1.25 times the distance between the tweeters on each speaker. Therefore, in a long, rectangular room of 12' x 18', if the speaker tweeters are going to be 9' apart, you should be sitting 9'11" to 11'3" from the speaker. This would be more than halfway down the long axis of the room.

Many people place the speakers on one end and sit at the other end of the room. This approach will not yield the finest sound. Carefully consider your listening position. Our experience has shown that any listening position that places your head closer than 14" from a wall will diminish the sonic results of your listening due to the deleterious effects of boundary interaction.

Speaker Orientation

Speaker placement and orientation are two of the most important considerations in obtaining superior sound. The first thing you need to do is eliminate the sidewalls as a sonic influence in your system. Speakers placed too close to the sidewalls will suffer from a strong primary reflection. This can cause out-of-phase cancellations, or comb filtering, which will cancel some frequencies

and change the tonal balance of the music. Adhering to the Wilson Audio Setup Procedure outlined in the previous section is the best method with which to position your loudspeakers.

A very important aspect of speaker placement is how far from the back wall to place the speakers. The closer a loudspeaker is to the back wall, the more pronounced the low bass energy and centering of the image will be. However, this comes at a definite reduction in stage size and bloom as well as



a deterioration of upper bass quality. You must find the proper balance of these two factors, but remember, if you are partial to bass response or air and bloom, do not overcompensate your adjustments to maximize these effects. Overcompensated systems are sometimes pleasing in the short-term, but long-term satisfaction is always achieved through proper balance.

To make correct in-home set up of the Sasha DAW possible without test equipment, Wilson Audio has measured the correct geometric time domain alignment for different distance/ear height combinations. See the next section for details. By measuring the distance from the bottom-front baffle of your speaker to your ear when seated in the listening position, as well as height of the listener's ear measured from the floor, you will be able to align the system for your listening position.

The Sasha DAW is designed for maximum phase coherence and pulse replication accuracy when each speaker is aimed directly at the listener. Thus, Sasha DAW should be "toed in." In other words, the listener, when seated in the listening position looking forward with his/her head in a rested position, should just barely see the surface of the inner side of each Sasha DAW. Toeing in the speakers provides meaningful improvements in resolution of low-level detail in the midrange as well as appreciable improvements in soundstaging performance.

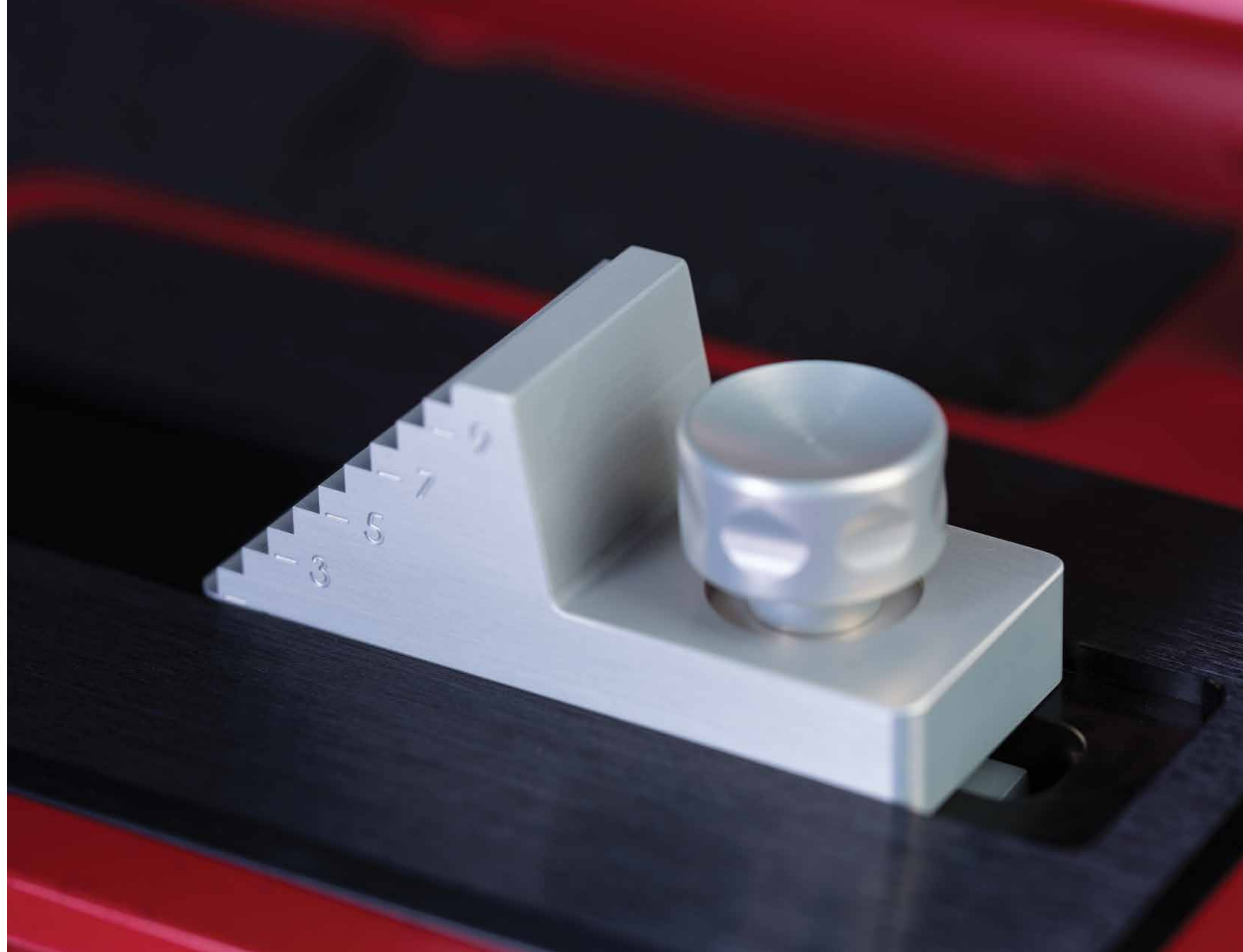



SECTION 2—SASHA DAW ASSEMBLY

Note: You will have two Upper Module enclosures as well as two Woofer Module enclosures to unpack. The two modules will need to be separated into right and left channels. Clear out two spaces, one for your left and one for your right channels. Place the ODD numbered modules in the LEFT channel section and the EVEN in the RIGHT channel position.

Section 2.1—Uncrating the Sasha DAW

Note: Before uncrating your Sashas, remove all jewelery such watches, rings, and bracelets to avoid scratching the painted surface.

Initial Check

The Sasha DAW is shipped in three wooden crates. Upon receiving these crates, please check their condition. If any of the crates are damaged, please report it to the shipping company immediately for insurance verification.

The following items are recommended for this procedure:

- Electric Screwdriver
- Phillips head drive bit

Uncrating the Woofer Module

A minimum of two strong adults is required to set up the Sasha DAW. Locate the two largest crates labeled “Sasha DAW Lower.” These contain the woofer enclosures and are the first components of the system to unpack.

1. With the crate lid facing up, unscrew the wood screws securing the lid. Remove the lid.
2. Carefully turn the crate upright so that the Woofer Module is now vertical. With the Woofer Module’s bottom toward the floor, reach in and gently slide the Woofer Module out of the crate, carefully, so as not to hit the Woofer Module on the crate and scratch the paint.
3. Place the Woofer Module with an odd serial number on the left side of the room and the Woofer Module with an even serial number on the right side of the room.

Note: These two woofer enclosures are very heavy and care should be taken to prevent injury.

Uncrating the Upper Module

The Upper Modules are contained in a single crate. Unpack the modules using the following procedure:

1. With the crate lid facing up, unscrew the wood screws securing the lid. Remove the lid.
2. The Upper Module crate contains the owner’s manual and tool kit. Remove these.

3. When removing the upper modules, take care so as not to hit the modules on the crate and scratch the paint. Using the small shelf on the rear of the module, tilt it so there is access to the bottom side. Slide the other hand under the Upper Module for support, and carefully lift the enclosure out of the crate.
4. The cloth grilles are attached to the modules. Detach the grilles from the module and remove the protective plastic covering the grill.
5. Place the Upper Module with an odd serial number on the left side of the room and the module with an even serial number on the right side of the room.

Section 2.2—Crate Content Checklist

Now that you have unpacked your Sasha DAWs, you can inventory all the additional items in the crates.

- Owners Manual
- Full-Line Product Brochure
- Warranty Registration Form
- (1x) Polishing Cloth
- (8x) ½"-13 Spike with Nut
- (8x) LG ½"-13 Mechanical Diode

- (8x) ½"-13 [1 ½"] Set-Screw
- (8x) Large Aluminum Spike Pad
- (4x) "AA" Spike
- (2x) #2 Spike
- (2x) #3 Spike
- (2x) #4 Spike
- 1/2" Nut Driver (binding posts)
- 3/4" Combo Wrench (spike nuts)
- 2" Caster Wrench
- 7/16" Ratchet Wrench (alignment spikes)
- Universal Allen Driver
- 3/32" Allen Bit (resistor screws)
- 1/8" Allen Bit (woofer resistor panel screw)
- 5/32" Allen Bit (driver screws)
- 1/4" Allen Elbow (diode set-screws)

Note: After set up of the system, keep the shipping crates in case of future shipping needs.

Note: Before setting up the Sasha DAW, study carefully Section 1, "In Your Room." It provides valuable information on determining the ideal room location for your speakers.

Section 2.3—Initial Assembly

Preparation

You will need the following items:

- Supplied hardware kit
- Tape measure
- Propagation Delay Correction Tables (Section 5).
- Known listening position
- Masking Tape

Take a moment to familiarize yourself with the top of the tables contained in Section 5. There are two tables, which contain important information on the Sasha DAW's adjustable Propagation Correction, that will be needed during the setup.

Upper Module Assembly

The Upper Module uses the combination of three spikes installed into the bottom of its enclosure. The spikes provide proper coupling of the Upper Module to the Woofer Module and are used to correct propagation delay. "AA" spikes are always installed in the front two positions (the threaded holes located near

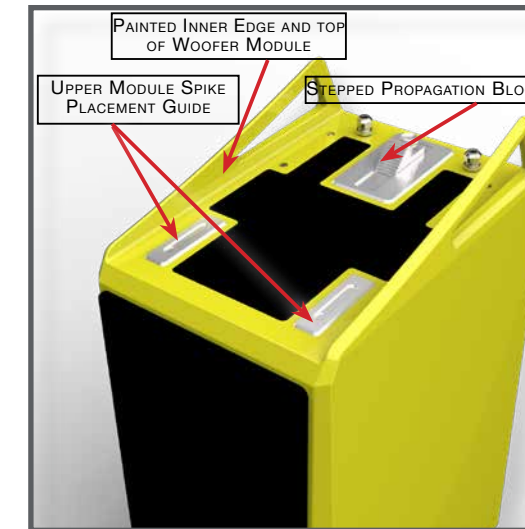

the bottom front of the enclosure). The spike-type is stamped in the round top of the spike. These two spikes screw into the Upper Module as shown to the left. The spikes should be screwed in all the way, until they are hand tight. Do not over tighten spikes.

Alignment Procedure

Locate the Alignment tables in Section 5. These tables contain critical information that will guide you to position the Upper Module for optimized propagation delay adjustment.

The rear of the Sasha DAW Upper Module assembly rests on a specific step in the Alignment Block. The position of the Upper Module is facilitated by the Alignment Block steps. The position is designated by the engraved numbers in the Alignment Block mounting plate. There are also four spike configurations, the use of which are determined by the distance/ear relationship of the installation. The three configurations are: no spike, a number 1, 2, 3, or 4 spike. The table in Section 5 contains information on the appropriate length spike to be used in the rear of the Upper Module. Propagation Delay Tables are also available on the Wilson Audio APP, which is available on iTunes and Android Marketplace.

Determine the alignment of each Upper Module as follows:

1. Repeat each step of this procedure on the left and right channels simultaneously.

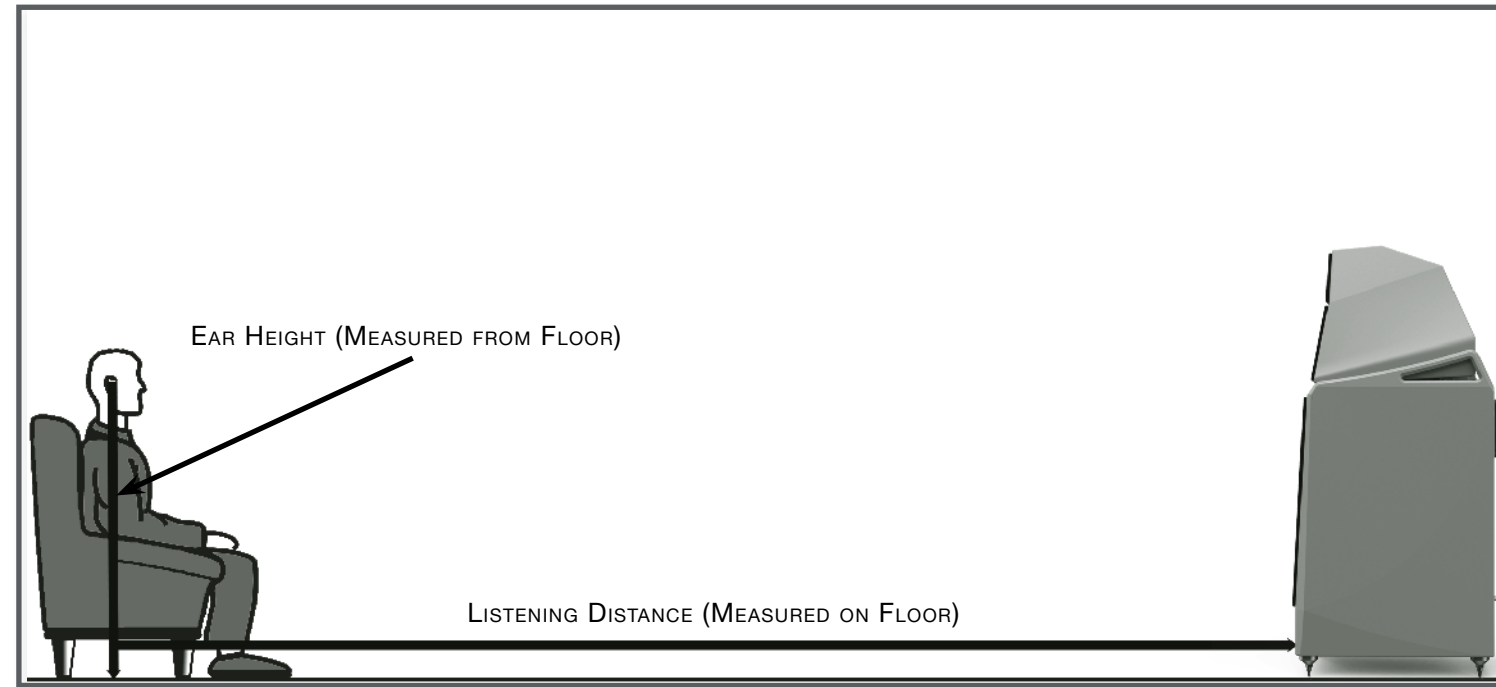

2. Make sure that you are in your intended listening position.
3. While sitting, have someone measure your ear height from the floor directly below your ear canal. You should be relaxed in your chair, as you would be when listening to music (see graphic above).
4. Now measure the distance (on the floor) from the point on the floor below your ear to the base of the loudspeaker, as shown in graphic above.
5. Refer to the Propagation Delay Tables and locate the corresponding ear height

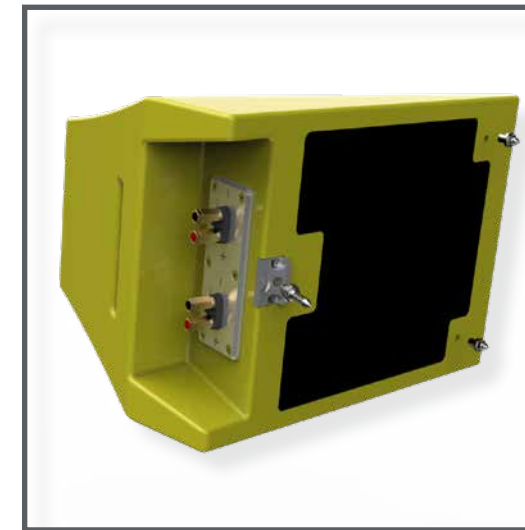

for each module. There are two charts for the positioning of the Upper Module. The first: “Sasha DAW Spike Length” is a table determining the rear spike length. The Second, “Sasha DAW Alignment Block Step,” specifies the step on which the rear spike will rest.

6. Make a mark on the chart Number 1 “Sasha DAW Upper Module Spike Length” indicating the proper rear spike for this module as determined by the ear height and distance from listening position.

Note: The shortest spikes (labeled AA) are always used at the front of the Upper Module.

7. Make a mark on the second chart labeled “Sasha DAW Upper Alignment Block Step” indicating Upper Module spike’s resting position on the alignment block. Set this information aside as you will refer to it in the next section. (See Section 5.)

Section 2.4—Mounting the Upper Module

Materials Required:

1. Correct spikes for the upper module.
2. Section 5 shows the use of the proper length of rear spike of

the upper module. Refer to the Sasha DAW Propagation Delay Tables and the procedure in the previous section to determine the correct Aspherical Propagation delay spikes as necessary, the Alignment Block position, and the proper step location on which to place the rear spike.

Install the Upper Module As Follows:

1. Install the front pair of short (AA length) spikes into the bottom of each module.
2. Refer to the table labeled “Sasha DAW Upper Spike Length” in Section 5 and install the appropriate rear spike if necessary.
3. Refer to table labeled “Sasha DAW Upper Alignment Block Step” in Section 5. Using the numbers engraved on the side of the back, make sure the spike rests on the correct alignment step.

NOTE: Take caution not to scratch the painted surface with the alignment spike as you install the Upper Module.

Note: Ensure that the two front spikes are properly seated in their receptacles and that the Upper Module is not skewed atop the Woofer Module. The Upper Module sides should be parallel to the sides of the Woofer Module. This will ensure correct propagation alignment of the drivers.

Umbilical Connections



The correct connection of the two umbilicals to the Upper Module is as follows:

1. There are two sets of connections on the Upper Module, one for the midrange and the other for the tweeter.
2. Locate the cable marked “MID FREQ.” This cable exits the Woofer Module just below the appropriate connector. Connect the RED lug of the cable to the RED (positive) terminal on the Upper Module. Connect the black lug of the cable to the BLACK (negative) terminal.
3. Locate the cable marked “TWEETER.” Repeat Step 2 above.

Note: Please ensure that you do not invert the polarity of the umbilicals in the Sasha DAW. Such an inversion will produce entertaining ambient effects, but destroys the linearity and harmonic structure of the system.



SECTION 3—FINAL SETUP

Section 3.1 – Spiking the Sasha DAW

Your dealer is trained in the art and science of the Wilson Audio Setup Procedure (WASP) outlined in Section 1.2. Before the spike/diode assemblies are attached to the bottom of Sasha DAW, the set up and fine tuning of your loudspeaker should be completed. Before spiking Sasha DAW, use masking tape to carefully mark their location.

Woofer Module Spikes

Included with Sasha DAW are two sets of Woofer Module spikes, which provide acoustical isolation as well as optimal height placement for your speakers. There are two ways of assembling the spikes (with or without the diode).

Your choice will depend on your listening room and personal tastes.

Spike/Diode Assembly

1. Locate the spike assembly. On the spike, move the nut to about two threads from the point. This will allow for greater movement when leveling the loudspeaker system.
2. Screw the spikes into the diode until the nut is against the diode. Be careful that the nut does not turn while inserting and threading spikes into the diode.

Note: Do not tighten these assembled spikes. You will need to unscrew

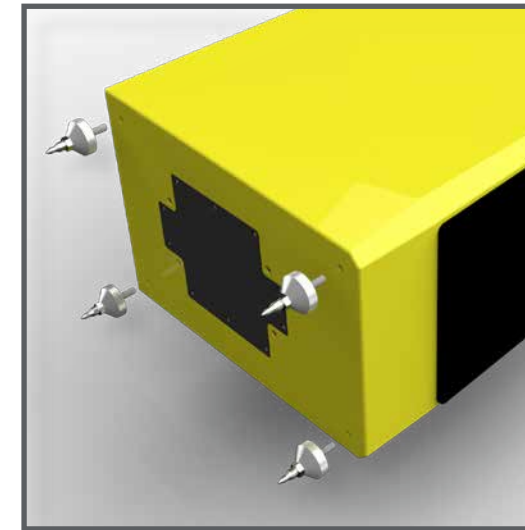
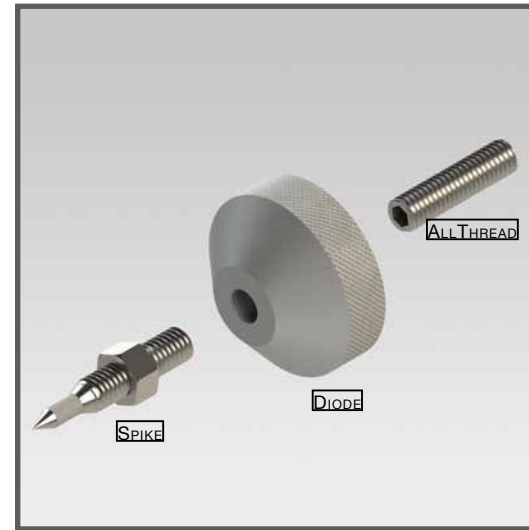

them when you level the Sasha DAW. This will ensure that if for any reason you have to remove Sasha DAW spikes, you will be able to withdraw the set screw using the supplied Allen wrench.

3. Screw the all-thread set screw into the diode until it meets the spike for your system. Make sure the allen head portion of the all-thread faces toward the spike.
4. Assemble the rest of the spikes/diode.

Spike Installation Procedure

5. Remove the Upper Module from the Woofer Module.
6. Carefully lay the Woofer Module on its side.
7. Insert the spike/diode assemblies into the four holes located on the bottom of each Woofer Module. Tighten until the top surface of the Woofer Module Spike (or spacer) touches the bottom surface of the "X" material plate.

Note: The spike receptacles are tapped directly into the "X" material plate on the bottom of the Woofer Module. Be very careful NOT TO CROSS THREAD the spikes.

Section 3.2—Leveling the Sasha DAW

1. Place a level on the left to right oriented axis in the flat area atop the woofer behind the Upper Module. If it is level, move to the next step.
2. You may rotate the spike tips in place by hand..
3. Lengthen the appropriate spike or spikes (not the Woofer Module Spike diode on the set screw) on that lower side until the Sasha DAW is level.
4. If the speaker is leaning to the left, lengthen both Woofer Module spikes on the right hand side of the speaker. If the speaker is leaning right, lengthen the left hand spikes. Lengthen the spikes incrementally, checking and rechecking the level until the Sasha DAW is level left to right.
5. Place a level on the front to back oriented axis. If it is level, then Sasha DAW is level. If the Sasha DAW is leaning one way or the other, following the same process as above, lengthen the appropriate spikes on the front or rear of the Woofer Module until the Sasha DAW is level.
6. To find out which spike to lower, grasp the Sasha DAW channel and gently rock it back and forth. This will identify the spike

that is out of level from the other three. If there is movement, lengthen the appropriate spike until the Sasha DAW sits solidly on the floor. Make sure the spike is penetrating the carpet surface and is resting on the solid floor beneath.

7. Once all adjustments have been made, with the 3/4" wrench provided, tighten the nut on the spike to the diode. DO NOT OVERTIGHTEN! "Snug" is tight enough.

Section 3.3—Removing the Protective Film

To protect the finish of the Sasha DAW during final manufacture, shipment, and setup in your listening room, we have applied a removable layer of protective film over the finish. We recommend that this film be left in place until the speakers are in their final location in your listening room. Once you have determined their final position, remove the film by following this procedure:

1. Ensure the speaker surface is room temperature before removing the protective film. Removing the protective film when the speaker surface is cold can damage the paint surface.
2. Slowly remove the film from the top down, large sections at a time, gently pulling the film downward and outward. Tearing the film aggressively can damage the paint.
3. Take care in removing the protective film near edges and cor-

ners to prevent paint damage in these areas.

4. The protective film should not be left on the painted surface for extended periods of time nor exposed to heat sources and direct sunlight.



Section 3.4—Resistors

Midrange and Tweeter Resistors

By removing the large aluminum back cover on the rear of the woofer module of your Sasha DAWs, you may gain access to the resistor plate. These resistors serve several functions.

Note: Only Wilson Audio replacement resistors should be used in your Sasha DAWs. Changing the value or brand of resistor will have a deleterious affect on the sonic performance of your loudspeakers and will void your Wilson Audio Warranty.

The Tweeter Level, which consists of two 6.0 ohm resistors in parallel, and Midrange Level, which consists of two 4.8 ohm resistors in parallel, resistors provide precise level matching for the midrange and tweeter drivers correspondingly. The resistors also act as ultra high quality fuses which open before a driver can be damaged by excess power.

Additionally, these resistors can be used to tailor the output of the corresponding driver to overcome tonal balance issues that result from room acoustics.

Woofer Damping Resistor

The Woofer Damping resistor affects the way the Sasha DAW's woofers couple to the amplifier. These resistors are pre-installed in the base of the Bass Module and should not be changed.

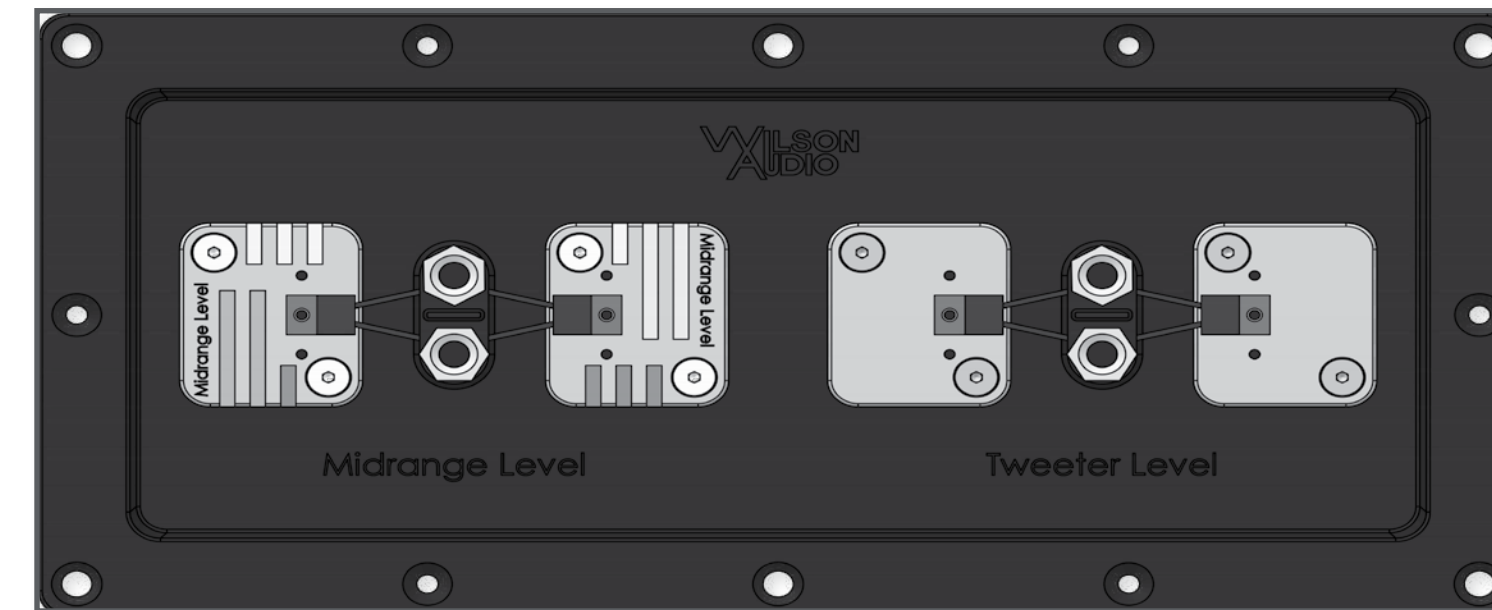



SECTION 4—SPECIFICATIONS

Section 4.1—Specifications:

Enclosure Type Upper Module: Rear Vented Midrange, X&S-Material

Enclosure Type Woofer Module: Rear Ported Woofer, X-Material

Woofers: Two – 8 inch (20.32 cm)

Midrange One – 7 inch (17.78 cm)

Tweeter: One – 1 inch, Dome (2.54 cm)

Sensitivity: 91 dB (one watt at one meter at 1kHz)

Nominal Impedance: 4 ohms / minimum 2.48 ohms @ 85 Hz

Minimum Amplifier Power: 25 watts per channel

Frequency Response: 20 Hz –30 kHz +/- 3 dB room average response [RAR]

Overall Dimensions: Height – 44 3/4 inches (113.67 cm)

Width – 14 1/2 inches (36.83 cm)

Depth – 22 15/16inches (58.26 cm)

Sasha DAW Weight Per Channel: 236 lbs (107.05 kg)

System Shipping Weight (approx.): 710 lbs (322.05 kg)

Section 4.2—Graphical Dimensions:

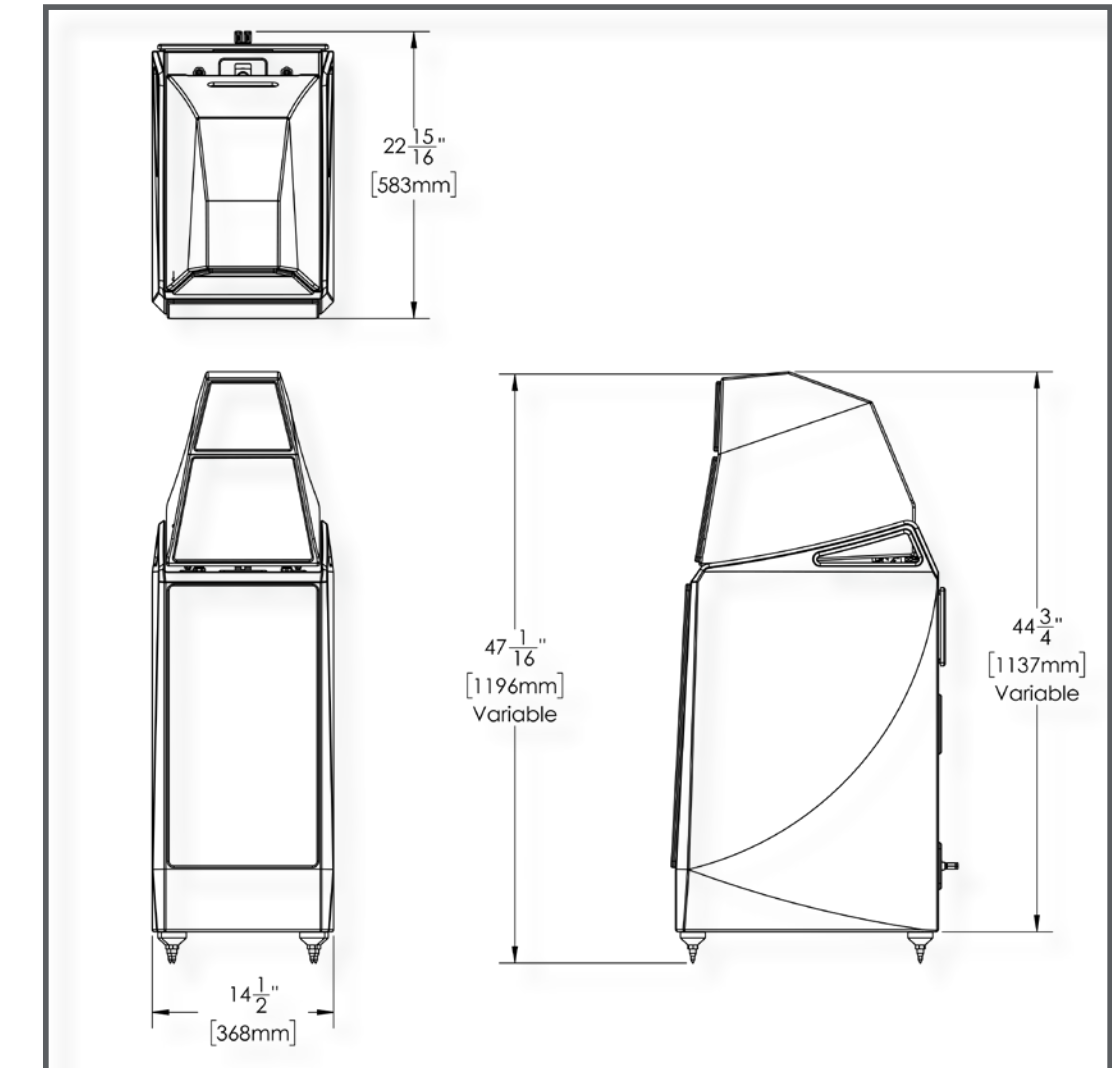



SECTION 5—TIME-ALIGNMENT CHARTS

Section 5—Propagation Delay Nomographs

Sasha DAW Upper Spike Length													
Ear Height		Listening Distance											
		8 ft 2.44 m	9 ft 2.74 m	10 ft 3.05 m	11 ft 3.35 m	12 ft 3.66 m	14 ft 4.27 m	16 ft 4.88 m	18 ft 5.49 m	20 ft 6.1 m	22 ft 6.71 m	24 ft 7.32 m	26 ft 7.92 m
48 in	122 cm	-	-	No Spike	No Spike	No Spike	No Spike	No Spike	No Spike	No Spike	No Spike	No Spike	No Spike
46 in	117 cm	No Spike	No Spike	No Spike	No Spike	No Spike	No Spike	No Spike	No Spike	No Spike	No Spike	No Spike	No Spike
44 in	112 cm	No Spike	No Spike	No Spike	No Spike	No Spike	No Spike	No Spike	No Spike	No Spike	No Spike	No Spike	No Spike
42 in	106.5 cm	No Spike	No Spike	No Spike	No Spike	No Spike	No Spike	No Spike	No Spike	No Spike	No Spike	No Spike	No Spike
40 in	101.5 cm	No Spike	No Spike	No Spike	No Spike	No Spike	No Spike	No Spike	No Spike	No Spike	No Spike	No Spike	No Spike
38 in	96.5 cm	2	2	2	2	2	No Spike	No Spike	No Spike	No Spike	No Spike	No Spike	No Spike
36 in	91.5 cm	3	2	2	2	2	2	No Spike	No Spike	No Spike	No Spike	No Spike	No Spike

Sasha DAW Upper Alignment Block Step													
Ear Height		Listening Distance											
		8 ft 2.44 m	9 ft 2.74 m	10 ft 3.05 m	11 ft 3.35 m	12 ft 3.66 m	14 ft 4.27 m	16 ft 4.88 m	18 ft 5.49 m	20 ft 6.1 m	22 ft 6.71 m	24 ft 7.32 m	26 ft 7.92 m
48 in	122 cm	-	-	2	2	2	2	3	3	3	3	4	4
46 in	117 cm	2	3	3	3	3	3	4	4	4	4	4	4
44 in	112 cm	4	4	5	5	5	5	5	5	5	5	5	5
42 in	106.5 cm	7	5	6	5	6	6	6	6	6	6	6	6
40 in	101.5 cm	9	8	8	8	7	7	7	7	7	6	6	6
38 in	96.5 cm	2	1	1	1	1	8	8	8	7	7	7	7
36 in	91.5 cm	1	3	3	2	2	1	1	9	8	8	8	8



SECTION 6—WARRANTY

WILSON AUDIO SPECIALTIES

Section 6—Warranty Details

Limited Warranty

Subject to the conditions set forth herein, Wilson Audio warrants its electronics to be free of manufacturing defects in material and workmanship for the Warranty Period. The Warranty Period is a period of 90 days from the date of purchase by the original purchaser, or if both of the following two requirements are met, the Warranty Period is a period of five (5) years from the date of purchase by the original purchaser:

Requirement No. 1. No later than 30 days after product delivery to the customer, the customer must have returned the Warranty Registration Form to Wilson Audio. Alternatively, the warranty may be filled out on-line.

Requirement No. 2. The product must have been professionally installed by the Wilson Audio dealer that sold the product to the customer.

FAILURE TO COMPLY WITH EITHER REQUIREMENT NO. 1 OR REQUIREMENT NO. 2 WILL RESULT IN THE WARRANTY PERIOD BEING LIMITED TO A PERIOD OF 90 DAYS ONLY.

Conditions

This Limited Warranty is also subject to the following conditions and limitations. The Limited Warranty is void and inapplicable if the product has been used or handled other than in accordance with the instructions in the owner's

manual, or has been abused or misused, damaged by accident or neglect or in being transported, or if the product has been tampered with or service or repair of the product has been attempted or performed by anyone other than Wilson Audio, an authorized Wilson Audio Dealer Technician or a service or repair center authorized by Wilson Audio to service or repair the product. Contact Wilson Audio at (801) 377-2233 for information on location of Wilson Audio Dealers and authorized service and repair centers. Most repairs can be made in the field. In instances where return to Wilson Audio's factory is required, the dealer or customer must first obtain a return authorization. Purchaser must pay for shipping to Wilson Audio, and Wilson Audio will pay for shipping of its choice to return the product to purchaser. A RETURNED PRODUCT MUST BE ACCOMPANIED BY A WRITTEN DESCRIPTION OF THE DEFECT. Wilson Audio reserves the right to modify the design of any product without obligation to purchasers of previously manufactured products and to change the prices or specifications of any product without notice or obligation to any person.

Remedy

In the event that the product fails to meet the above Limited Warranty and the conditions set forth herein have been met, the purchaser's sole remedy under this Limited Warranty shall be to: (1) contact an authorized Wilson Audio Dealer within the Warranty Period for service or repair of the product without

charge for parts or labor, which service or repair, at the Dealer's option, shall take place either at the location where the product is installed or at the Dealer's place of business; or (2) if purchaser has timely sought service or repair and the product cannot be serviced or repaired by the Dealer, then purchaser may obtain a return authorization from Wilson Audio and at purchaser's expense return the product to Wilson Audio where the defect will be rectified without charge for parts or labor.

Warranty Limited to Original Purchaser

This Limited Warranty is for the sole benefit of the original purchaser of the covered product and shall not be transferred to a subsequent purchaser of the product, unless the product is purchased by the subsequent purchaser from an authorized Wilson Audio Dealer who has certified the product in accordance with Wilson Audio standards and requirements and the certification has been accepted by Wilson Audio, in which event the Limited Warranty for the product so purchased and certified shall expire at the end of the original Warranty Period applicable to the product.

Demonstration Equipment

Equipment, while used by an authorized dealer for demonstration purposes, is warranted to be free of manufacturing defects in materials and workmanship for a period of five (5) years from the date of shipment to the dealer. Demo

equipment needing warranty service may be repaired on-site or, if necessary, correctly packed and returned to Wilson Audio by the dealer at dealer's sole expense. Wilson Audio will pay return freight of its choice. A returned product must be accompanied by a written description of the defect. Dealer owned demonstration equipment sold at retail within two (2) years of date of shipment to the dealer is warranted to the first retail customer to be free of manufacturing defects in materials and workmanship for the same time periods as if the product had originally been bought for immediate resale to the retail customer. Wilson Audio products are warranted for a period of 90 days, unless extended to 5 years, as provided above, by return and filing of completed Warranty Registration at Wilson Audio within 30 days after product delivery to customer and the product was professionally installed by the Wilson Audio Dealer that sold the product to the customer.

Miscellaneous

ALL EXPRESS AND IMPLIED WARRANTIES NOT PROVIDED FOR HEREIN ARE HEREBY EXPRESSLY DISCLAIMED. ANY LEGALLY IMPOSED IMPLIED WARRANTIES RELATING TO THE PRODUCT SHALL BE LIMITED TO THE DURATION OF THIS LIMITED WARRANTY. THIS LIMITED WARRANTY DOES NOT EXTEND TO ANY INCIDENTAL OR CONSEQUENTIAL COSTS OR DAMAGES TO THE PURCHASER.

Some states do not allow limitations on how long an implied warranty lasts or an exclusion or limitation of incidental or consequential damages, so the

above limitations or exclusions may not apply to you. This Limited Warranty gives you specific legal rights, and you may also have other rights, which vary from state to state.