

AUTHENTIC EXCELLENCE PRODUCT AND ACCESSORY GUIDE



WILSON<sup>®</sup>  
AUDIO

WA DEALERS



**Wilson Audio® is a registered trademark of Wilson Audio Specialties, Inc.**

Wilson Audio (Stylized)®, WAMM®, Master Chronosonic®, WAMM Master Subsonic®, Chronosonic XVX®, Alexx®, Alexx V®, Alexia®, Alexia V®, Sasha DAW®, Yvette®, Sabrina®, SabrinaX®, Alida®, TuneTot®, LōKē®, Thor's Hammer®, Pedestal®, Wilson Audio Acoustic Diode®, Reliable Capacitor®, Rel-Cap®, AudioCap®, AudioCapX®, WATCH®, IsoBase®, Wilson Audio Authentic Excellence®, Wilson Audiophile Recordings LLC®, and Special Applications Engineering® are registered trademarks of Wilson Audio Specialties, Inc.

Chronosonic XVX 4 Seasons™, Grand SLAMM™, Sasha V™, Sasha W/P™, WATT™, WATT/Puppy™, Sophia™, Alida CSC™, Mezzo CSC™, WASAE Center™, WATCH Center™, XS™, Submerge™, WATCH Dog™, ActivXO™, Excellence in All Things™, Certified Authentic™, It's About Time™, WilsonGloss™, Convergent Synergy Carbon™, QuadraMag™, X-Material™, S-Material™, and V-Material™ are trademarks of Wilson Audio Specialties, Inc.

This brochure was produced by the Wilson Audio Marketing Department. The information contained herein is subject to change without notice.

**Current Revision 1.0 of Volume 6.** If you are in need of a more recent brochure, please contact your Dealer or download one at [www.wilsonaudio.com](http://www.wilsonaudio.com).

The information in this brochure is the sole property of Wilson Audio Specialties, Inc. Any reproduction, in whole or in part, without the express written permission of Wilson Audio Specialties, Inc., is prohibited. No material contained herein may be transmitted in any form or by any means, electronic or mechanical, for any purpose, without the express written permission of Wilson Audio Specialties, Inc.

*Copyright © 2023 Wilson Audio Specialties, Inc.*

# CONTENTS

<b>FLOOR-STANDING LOUDSPEAKERS.....</b>	<b>3</b>
SABRINAX.....	5
YVETTE .....	13
SASHA V .....	19
ALEXIA V.....	29
ALEXX V.....	37
CHRONOSONIC XVX.....	45
WAMM MASTER CHRONOSONIC .....	57
<b>SPECIAL APPLICATIONS ENGINEERING &amp; HOME THEATER .....</b>	<b>67</b>
TUNETOT (BOOKSHELF/STAND MOUNT) .....	69
ALIDA (WALL MOUNT/ATMOS).....	79
PEDESTAL (ELECTRONICS ISOLATION) .....	87
WILSON AUDIO ACOUSTIC DIODE (SPEAKER FOOTER) .....	93
WATCH (HOME THEATER PRODUCTS) .....	95
<b>SUBWOOFERS .....</b>	<b>103</b>
LÖKĚ.....	105
W.A.T.C.H. DOG .....	109
THOR’S HAMMER .....	113
WILSON AUDIO SUBSONIC .....	119
WAMM MASTER SUBSONIC .....	123
ACTIVXO .....	126
<b>CERTIFIED AUTHENTIC PROGRAM.....</b>	<b>129</b>
<b>AUTHENTIC PARTS &amp; ACCESSORIES .....</b>	<b>133</b>
<b>WILSONGLOSS COLORS .....</b>	<b>134</b>





# Floor-Standing Loudspeakers

AUTHENTIC EXCELLENCE



# SabrinaX<sup>®</sup>

*"With the SabrinaX's in the house, I smiled whenever I thought about the last time I'd listened to music and looked forward to the next time I'd be able to."*

**Brian Damkroger, *Stereophile***

AUTHENTIC EXCELLENCE





## Flagship DNA

The Chronosonic XVX is Wilson Audio's most ambitious and complex production loudspeaker to date. Daryl Wilson and his team of designers and engineers borrowed some of its technology from the limited-edition WAMM Master Chronosonic, itself the beneficiary of the most prolonged and intense research-and-development cycle in the history of the company. Much of the technology and many of the features of the XVX, however, are new and specific to that model. Indeed, Wilson introduced more new performance and ergonomic elements in the XVX than during any other design effort.

Fresh on the XVX project's heels, Daryl and his team turned their attention to Wilson's smallest floorstander. The SabrinaX is a ground-up rethinking of the Sabrina, the universally loved, small, floorstanding loudspeaker from Wilson Audio. Like the original Sabrina, the new X-version is a rare combination of traditional Wilson hallmark attributes such as bass authority, dynamic resolution, midrange beauty and integrity, and a sense of inherent musical "rightness." Wilson's goal was to design a loudspeaker that could stand alongside much larger systems. Like its flagship sibling, the Chronosonic XVX, SabrinaX offers a level of dynamic contrast and harmonic expression that is the defining character of Wilson Audio loudspeakers.

## Enclosure

X-Material has long been the cornerstone of Wilson's composite technology. In its third iteration, X-Material remains unbeatable for its rigidity, inertness, intrinsic damping, and extreme hardness. For this reason, Wilson Audio's engineers deploy X-Material in several different applications throughout Wilson's model lineup. The original Sabrina utilized X-Material only in its baffle and lower spike plate. Now, the SabrinaX's outer enclosure is constructed entirely from X-Material. The SabrinaX cabinet comes that much closer to the near-silent ideal Wilson has relentlessly pursued for decades. The music emerges through SabrinaX from a blacker background. Bass transients and overall clarity are vastly improved. Listeners will hear superior "silence between the notes," which, among other factors, enhances SabrinaX's rhythmic timing and pace.

SabrinaX's new bracing system augments all the above qualities by further reducing cabinet-born resonances. Like all modern Wilson loudspeakers, the engineers meticulously utilized laser vibrometry in an exhaustive exploration of the best cabinet geometries.

Similar to those designed for the XVX's midrange modules, a new low-turbulence vent replaces the aluminum unit used in the older model. The vent is milled directly into its X-Material enclosure. The intrinsic strength of X-Material makes complex vent shapes possible, which improves the musicality and the overall sonic presentation in the midrange.



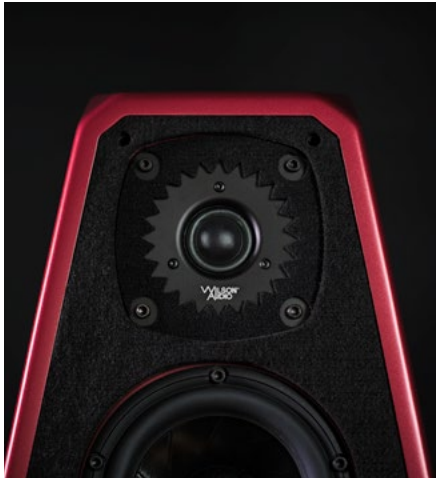

## Drivers

The tweeter chosen for SabrinaX is the Convergent Synergy MK5, which Daryl and the team developed initially for the limited-edition WAMM Master Chronosonic. The MK5 later became an integral part of the Chronosonic XVX's design. The Wilson tweeter combines ultra-low distortion, exquisite micro and macro contrast, and ultra-high resolution, all of which are accompanied by a sense of ease, accessibility, and supreme musicality.

The 5.75-inch midrange driver is remarkably smooth throughout its bandwidth (which extends flat to 1 kHz, facilitating the elevated crossover point to the tweeter). Midrange honesty, resolution, and beauty are the paramount qualities to all Wilson loudspeakers, and SabrinaX's midrange is no exception. The crossover points allow the driver to perform optimally within the "sweet spot" of its range.

The new 8-inch woofer designed and developed for the Sasha DAW's bass module now finds a home in the SabrinaX. This state-of-the-art driver is installed into an all-new, exceptionally inert bass cabinet, which provides the perfect platform for the driver's intrinsically excellent dynamic resolution and transient performance. Together, these elements contribute to a rich and yet ultra-fast midbass, which is, in turn, supported by an authoritative bass foundation. SabrinaX's bass articulation, transient speed, and bottom-octave extension will demolish any preconceptions about the bass quality and accuracy that such a small loudspeaker can produce.







## Hardware

Unlike the plastic items found in many high-end loudspeakers, Wilson ports have always been heroic. We machine this critical element from a solid billet of 6061-T6 aluminum. Over the years, we've refined our port shapes for better performance. For the SabrinaX, a new geometry effectively reduces already low port noise.

The new model utilizes the same Wilson designed-and-manufactured binding post as the XVX. It is easier to tighten by hand, and also features a banana-plug option. This unique Wilson Audio connector resets the bar for reliability and sonic integrity within high-current connections.

The SabrinaX uses the same spike/diode assembly found in much larger Wilson products, which increases the mechanical impedance path and improves vibration "draining." The larger diode also enhances the physical presence and beauty of the design.

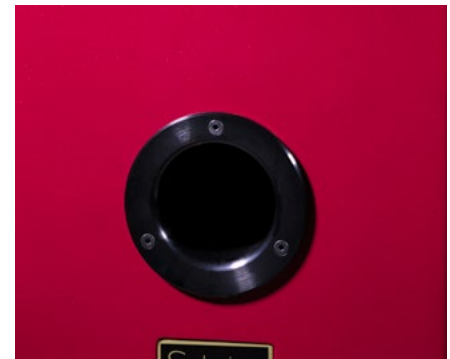
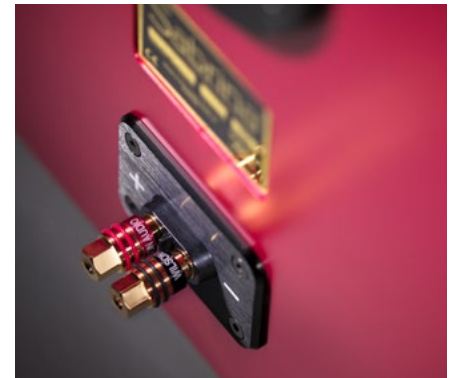





## Specifications

**Enclosure Type:** Rear Ported

**Woofers:** One—8 inches (20.32 cm)

**Midrange:** One—5 3/4 inches (14.61 cm)

**Tweeter:** One—1 inch (2.54 cm)

**Sensitivity:** 87 dB @ 1 Watt @ 1 Meter @ 1kHz

**Nominal Impedance:** 4 ohms / minimum 2.60 ohms @ 135 Hz

**Minimum Amplifier Power:** 50 Watts per channel

**Frequency Response:** 31 Hz – 23 kHz: +/- 3 dB: Room Average Response [RAR]

**Overall Dimensions:** Height—38 inches (96.48 cm) w/o spikes

Width—12 inches (30.48 cm)

Depth—15 5/16 inches (38.96 cm)

112 lbs each (50.80 kg)

**System Weight Per Channel (uncrated):** 275 lbs pair (124.73 kg) *boxes + pallet*

**System Shipping Weight (approx.):** 290 lbs pair (131.54 kg) *boxes with skids*



YVETTE®

*“For me, the organic design of the Yvette makes it the Wilson product that comes closest to the magic of an Apple design—and the one most pleasing to my eye. That beauty in the eye of this beholder, combined with its rich tonal palette, its facility to re-create a large lifelike soundstage and its flair for sounding larger than it is, make the Yvette my new reference—a speaker that fits my space and fulfills my requirements for engaging, dynamic, rich sound...”*

Dennis Davis, *The Audio Beat*

AUTHENTIC EXCELLENCE



## The Most Advanced Single-Enclosure Loudspeaker

It is natural to view the Yvette within the context of Wilson's past models. Early on in Wilson's history, Dave Wilson's WATT/Puppy literally transformed the high-end loudspeaker market. In an arena dominated by towering, multi-box behemoths, the WATT/Puppy was positively diminutive. But there was nothing small about its sound. Indeed, the WATT/Puppy redefined what audiophiles thought was possible in the areas of dynamic contrast, resolution, and soundstaging—all this from a domestically friendly form barely taller than a yardstick. The WATT/Puppy captured the imagination of the audiophile world, and went on to be the best selling loudspeaker in the over-\$10K category in history.

The Yvette may also invite comparison to another audiophile favorite, the Sophia. For thousands of music lovers and audiophiles, Sophia was their first hands-on experience with Wilson Audio. Sophia was treasured for her unparalleled combination of musicality and accessibility with other traditional Wilson virtues, such as dynamic contrast and soundstaging. She was, above all else, easy-going and eminently lovable.

The new Yvette draws from this rich tradition. But, perhaps more importantly, it derives its core technology directly from the enormous research-and-development reservoir of what is perhaps Wilson's most prolific era of innovation to date. Wilson's Alexia, and the leading-edge Alexx have all influenced the Yvette project, in some cases with identical components. And like the Alexx, the Yvette was developed alongside Dave Wilson's WAMM project.

It's no wonder, then, that the Yvette is the most advanced and musically refined single-enclosure loudspeaker in Wilson's history.





## Technology Engineered to Serve the Music

In conjunction with the WAMM project, Wilson Audio recently completed yet another wave of research into tweeter technology and exotic driver materials. They all fell well short of the musicality, natural resolution, and coherence of Wilson's tweeter. The Yvette employs the Convergent Synergy MK3 Tweeter, which is also found in the original Alexx. The MK3 features Wilson's exclusive rear-wave diffraction technology and ultra-low resonance rear chambers. It mates seamlessly with Wilson's proprietary midrange driver.



Wilson's venerable seven-inch midrange driver, the same unit in the Alexandria XLF, covers the all-important midrange. This proprietary Wilson driver has served several Wilson models, reproducing musically critical portions of the bandwidth with uncanny speed, resolution, and unprecedented dynamic and harmonic expression. Representing Wilson's commitment to veritable music reproduction, this seven-inch driver is destined to find a home on the list of all-time great drivers.



The ten-inch woofer chosen for the Yvette was (one of two woofers) originally developed for the Alexia, and is a cousin to the ten-inch in the original Alexx and the WAMM. These newest series of bass drivers are partially responsible for Wilson's trademark blend of dynamic contrast, impact, speed, and musicality. When installed in Yvette's bass enclosure, which was optimized for this driver in terms of volume and resonance control, it pushes the boundary of musical accuracy, extension, and dynamics for such a compact loudspeaker.





## Cutting-Edge Composites Developed by Wilson Audio

Wilson remains at the vanguard of enclosure technology. Like all recent Wilson designs, the Yvette is the beneficiary of Wilson's state-of-the-art composites research, the heart of which is the laser vibrometer. This measurement tool allows Wilson's engineers to see minute vibrations—on the order of a billionth of a meter.

Yvette's enclosure is built primarily from two Wilson-developed composites: the third generation of X-Material, an extremely well-damped and inert composite, and S-Material, which was developed for exquisite midrange performance. Bracing in this system is more ambitious and heroic than any previous single-enclosure system.

## Specifications

**Enclosure Type Woofer:** Rear Ported

**Enclosure Type Midrange:** Rear Vented

**Enclosure Type Tweeter:** Sealed

**Woofers:** One—10 inches (25.4 cm)

**Midrange:** One—7 inches (17.78 cm)

**Tweeter:** One—1 inch (2.54 cm)

**Sensitivity:** 86 dB @ 1W @ 1m @ 1 kHz

**Nominal Impedance:** 4 ohms / minimum 2.94 ohms @ 90 Hz

**Minimum Amplifier Power:** 50 Watts per channel

**Frequency Response:** 20 Hz – 25 kHz +/- 3 dB Room Average Response [RAR]

**Overall Dimensions:** Height—41 inches (104.14 cm) w/o spikes

Width—13 1/4 inches (33.66 cm)

Depth—20 1/16 inches (50.92 cm)

**System Weight Per Channel (uncrated):** 175 lbs each (79.38 kg)

**Total System Shipping Weight (approx.):** 515 lbs pair (233.60 kg)





SASHA V™

*"At its core, it's about our love of music. Sharing that love through the products we make is our goal."*

David A. Wilson II—1944-2018

AUTHENTIC EXCELLENCE



## The Shoulders of Giants

At Wilson Audio, we have forged an unwavering path towards "Excellence in All Things" in support of our guiding light, "Authentic Excellence." Continuously pushing the boundaries of what is possible, our passion for delivering an unparalleled listening experience is second to none and every milestone in Wilson Audio's history has paved the way for the exceptional.

In the late seventies David A. Wilson, Wilson Audio's visionary co-founder, was refining his experiments with adjustable modular arrays and how this time-centric approach to reproduced sound revealed more information in the recordings. Using the latest high-tech development tools available, this legacy still informs and inspires modern loudspeaker innovation.

With its own distinctive identity, Sasha V combines the essence of its predecessors while combining the most effective elements developed for its larger siblings.



## In Good Company

Wilson Audio's Engineers pulled from the monumental capabilities of our current flagship, the Chronosonic XVX, and the technology engineered specifically for Alexx V and Alexia V. By doing so Sasha V unravels your recordings in a surprisingly unexpected way for its relatively compact size.

Sasha V's exquisite craftsmanship and thoughtful contours create a sculpted masterpiece, beautifully integrating into your curated listening space, and stands as an embodiment of industrial art. But her allure reaches far beyond just aesthetic appeal.

No detail had been overlooked as the highest performing version of the Sasha line was created.

## Convergent Synergy Carbon

When Wilson Audio introduced its cutting-edge rear-wave chamber in the Convergent Synergy Carbon (CSC) Tweeter, initially in Alexx V, the CSC allowed for an extended high-frequency range, remarkably smooth linearity, and superior high-frequency harmonic expression. Cohesively integrating this CSC tweeter with the midrange and woofers has resulted in an impressive improvement to Sasha V's overall sound quality.

This unique and complex carbon fiber rear-wave chamber is constructed entirely in-house on one of our many dedicated 3D printers.

# SASHA EVOLUTION

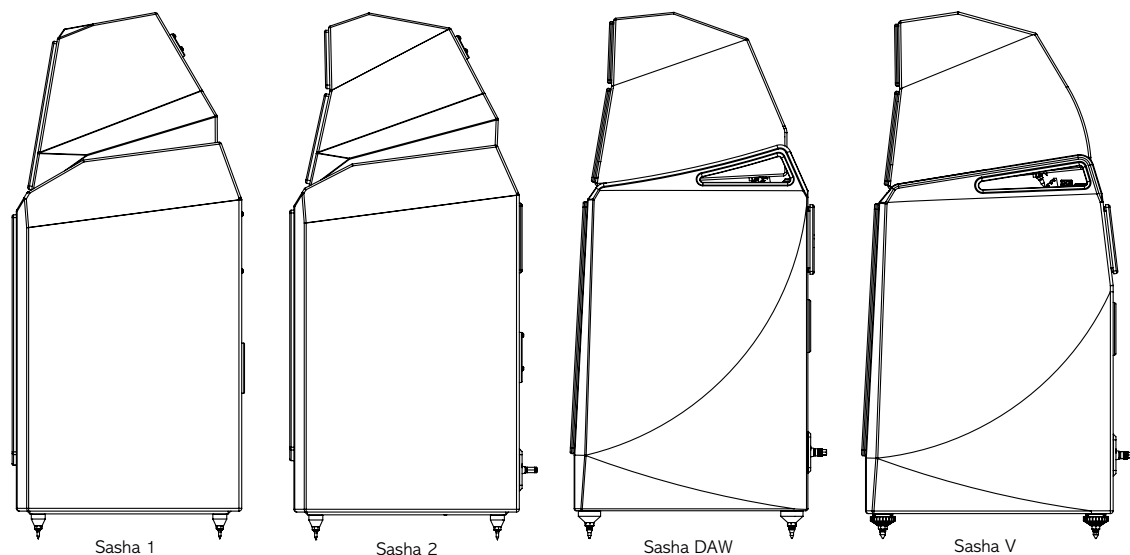

Here is a list of a few more upgraded elements found in the Sasha V:

- All external umbilical cables are terminated with the Wilson Audio spade as found on the Chronosonic XVX, Alexx V, and Alexia V.
- The streamlined stylized staircase alignment block makes the installation process and time alignment adjustments much easier.
- The upper module two-position front spike track offers additional adjustment positions the Sasha DAW doesn't have, resulting in more precise time alignment accuracy and more adaptability to a wider variety of listening positions.
- Wilson Audio formulated V-Cable is used for all internal connections creating continuity for the entire audio signal path which purely passes the signal from the main-in connector plate to the woofer crossover, upper crossover, and to all the drivers.
- Designed in-house, the custom Wilson Audio cable grip hardware distinctly works with V-Cable, ensuring the woofer cabinet is sealed and cable slack can be managed no matter what the upper module alignment location is set to.

## Premium Ingredients

The Sasha V also features a vast range of hardware upgrades, including the bespoke Wilson Audio multi-connector binding posts with modified knurling for a cleaner signal path. Installation choices are wider with the choice of either spade or banana plug speaker cables.

Made from the purest conductive metallurgies, Wilson Audio multi-connector binding posts ensure robust connection stability and are audibly more refined than plastic binding posts commonly found on loudspeakers.

The Sasha V resistor mounting hardware has been improved. This sleek carbon fiber back plate and aluminum framed glass cover, similar to Alexia V, now has tool-free, quick-release knurled thumbscrews for the tweeter and midrange resistors which facilitate simple servicing.

Looking at the back of the woofer top plate you see a flush mounted bubble level which gives a quick and reliable leveling system for better installation.

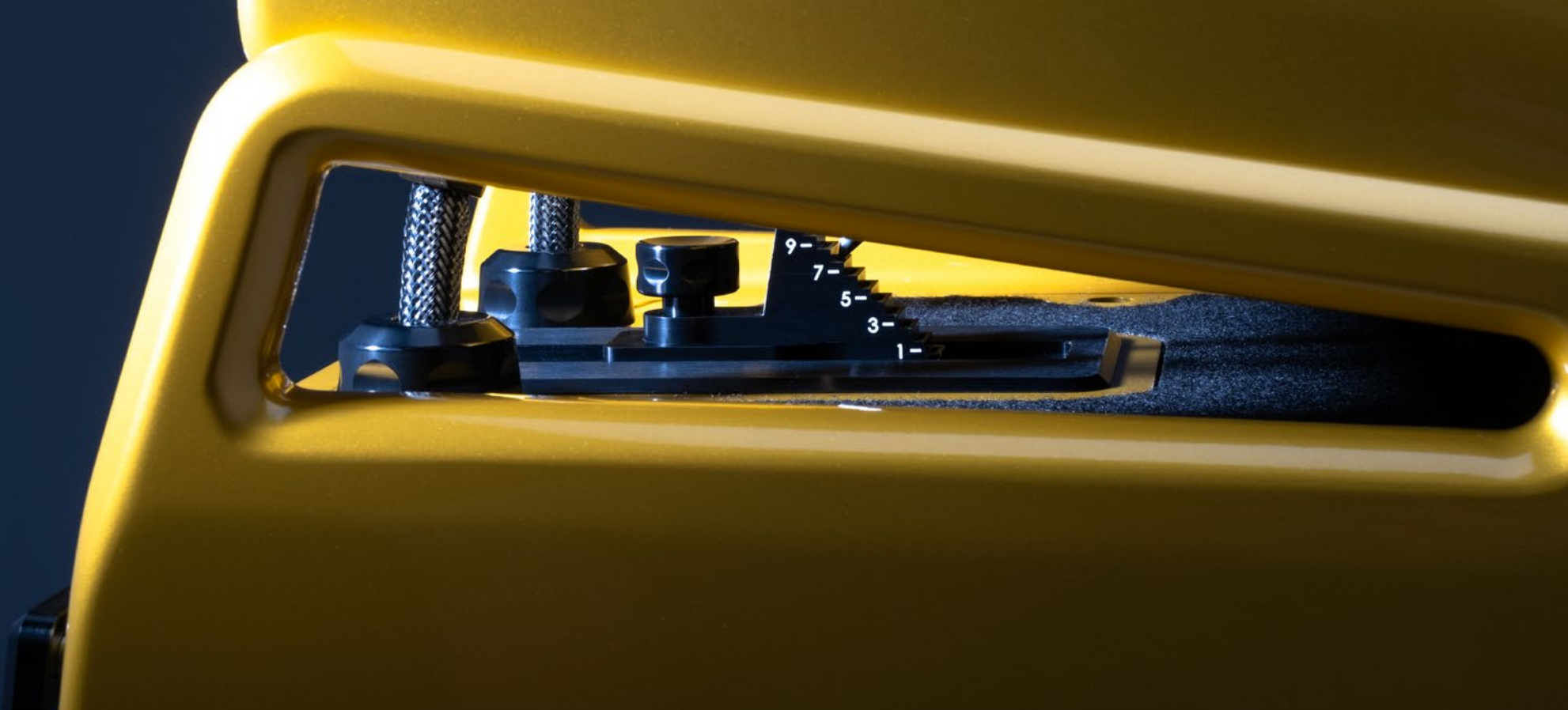

## Alnico QuadraMag

Perfect blending between the tweeter and midrange is a fundamental element to accurate and realistic sound reproduction. The R&D team successfully did just that. Wilson Audio's beloved 7-inch AlNiCo (Aluminum - Nickel - Cobalt) QuadraMag midrange driver sings harmoniously with the CSC tweeter in Sasha V.

This world-class midrange driver is celebrated for its superb settling and effortlessly revealing greater soundstage dimensionality in the frequency band that the human ear is most sensitive to. Once only available in the Chronosonic XVX, Alexx V, and the Alexia V, the QuadraMag is now a critical part of Sasha V.

The upper array baffle includes Wilson Audio's proprietary S-Material. This baffle is composed of a unique blend of materials that form a highly stable and low-resonance coupling surface for the mid-range driver, thus allowing the natural sonic beauty found in the QuadraMag to bloom.





## Material DNA

Sasha V has strategically nested V-Material in the critical interface between the upper module and the top of the woofer cabinet. Novel in its properties, this material provides uncommon vibration control and upper module isolation, similar to the design philosophy found in the prestigious Alexx V and Alexia V.

This proprietary V-Material is also recessed into the Wilson Audio Acoustic Diodes. These purpose-built spikes employ peerless vibration management which clearly expresses the system's dynamics and micro-detail.

Nature continues to inspire design cues in Wilson Audio creations. The organic flow of lines found throughout Sasha V create a harmonious integration between the lower and upper enclosures, all the while the structural integrity of both the upper and lower modules have been reinforced by the use of milled X-Material internal bracing.

The woofer enclosure side walls, made from solid X-Material, are 25% thicker compared to the Sasha DAW. The increase in dimension of the X-Material fortifies the enclosure, raises density, and is less prone to resonances that can compromise sonic nuances. Even with these enclosure changes, the Sasha V retains its sleek proportions.

## Wilson Audio Capacitors

Each custom capacitor, used in both of Sasha V's crossovers, have been wound and completed at Wilson Audio's in-house capacitor manufacturing department (Reliable Capacitors). These application specific capacitors are tightly spun and then hand-finished to industry-leading tolerances. Wilson Audio has heavily invested in highly sophisticated winding machines that have been solely crafted in Switzerland and the United States for Reliable Capacitors.

One of the many advantages of having RelCap in the building with Wilson Audio is the rapid prototyping of capacitors. An all-new copper version of the AudioCapX-WA capacitor has been recently developed, raising the bar for high-frequency micro detail, and makes its debut in the Sasha V. The AudioCapX-WA capacitors, along with fine-tuning the Sasha V's crossover topology, have contributed to a new standard of low-level resolution in a playback system.

Sasha V's crossovers are composed of world-class components and are passionately hand-made at Wilson Audio. Printed circuit boards, when used in loudspeakers, inherently dynamically compress the sound. Wilson Audio avoids this sonic issue by taking the time to painstakingly handcraft and join each component with point-to-point connections.

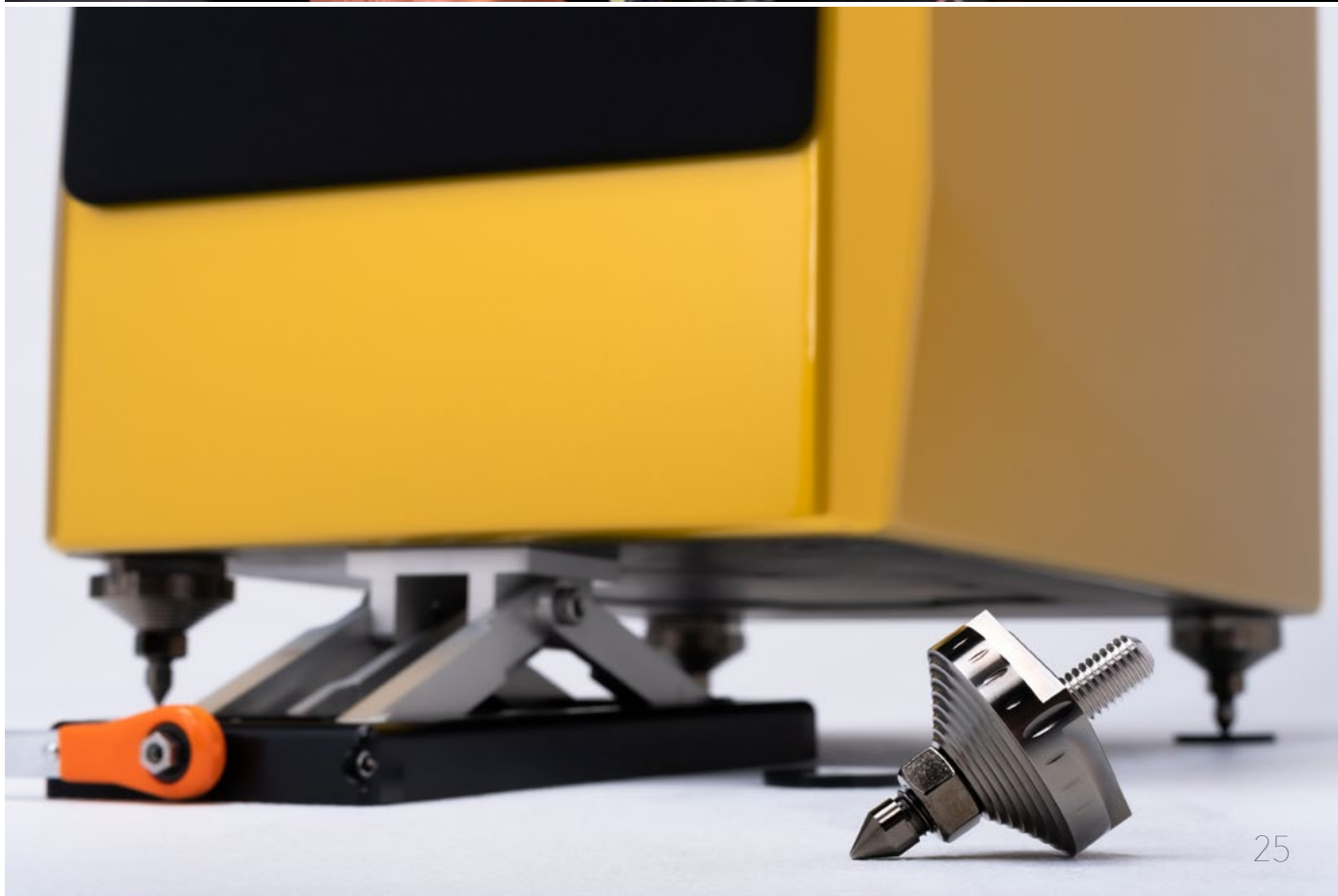





## Specifications

**Enclosure Type Woofer:** Rear Ported

**Enclosure Type Midrange/Tweeter:** Rear Vented

**Woofers:** Two—8 inches (20.32 cm)

**Midrange:** One—7 inches (17.78 cm)

**Tweeter:** One—1 inch (2.54 cm)

**Sensitivity:** 88 dB @ 1 Watt @ 1 Meter @ 1 kHz

**Nominal Impedance:** 4 ohms / minimum 2.36 ohms @ 82 Hz

**Minimum Amplifier Power:** 25 Watts per channel

**Frequency Response:** 20 Hz – 32 kHz +/- 3 dB Room Average Response [RAR]

**Overall Dimensions:** Height—45 1/16 inches (114.48 cm) w/o spikes

Width—14 1/2 inches (36.83 cm)

Depth—23 15/16 inches (60.78 cm)

**System Weight Per Channel (uncrated):** 245 lbs (111.13 kg)

**Total System Shipping Weight (approx.):** 760 lbs (344.73 kg)



ALEXIA V<sup>®</sup>

*“The Alexia V manages to bring order to musical chaos, in a way that I've never heard in an Alexia speaker, or anything in its class”*

Chris Connaker, *Audiophile Style*

AUTHENTIC EXCELLENCE

## A New Era for Alexia

Wilson Audio is well known for its continuous pursuit of "Excellence in All Things" and persistent R&D advancements. As development finished on Alexx V and as Alexia Series 2 reached its five year anniversary, Wilson Audio's Engineers were put to the test to see how far they could

push Alexia's performance envelope. What unfolded is nothing short of remarkable. More than thirty areas of improvement were identified and refined. Benefiting from the enormous evolutions found in Chronosonic XVX and Alexx V, Alexia V truly sits upon the shoulders of giants.

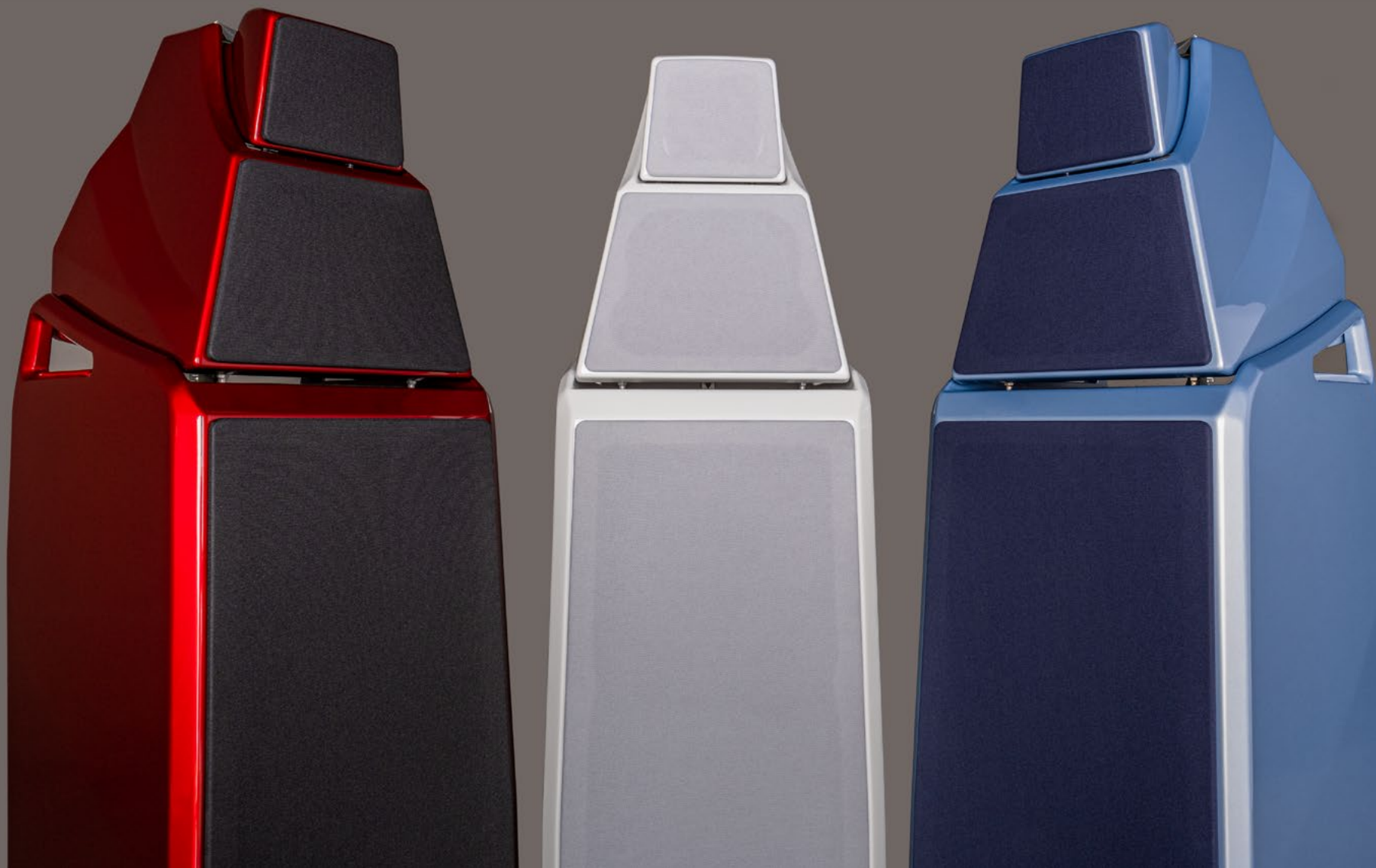





## Form Follows Function

Wind-swept fields and towering arches served as points of inspiration for the more svelte lines and thoughtfully distilled design of Alexia V. Alexia V's enclosures are crafted from many exotic and proprietary materials. Included in these handcrafted enclosures are: the latest versions of X-Material & S-Material, V-Material strategically nested throughout it's form, carbon fiber, aerospace grade aluminum, austenitic stainless steel, and gold connections throughout the entire signal path. Each element has been carefully chosen and optimized for its distinctive role in extraordinary sound reproduction.

V-Material is nested in the top of the woofer and midrange enclosures for increased vibration mitigation and control. By using X-Material throughout all three modules, and methodically refining the internal bracing and panel thicknesses, Wilson Audio's Engineers have enhanced enclosure damping to a new standard for this product category. Wilson's research has found S-Material to be a superior material option for midrange driver coupling and provides an open and accurate sonic presentation.



Exhaustive research into Alexia's time-alignment capabilities yielded results that have lead to every driver being better aligned with each other and more on-axis with the listener. From your recordings you will experience more resolved micro-details and tighter time-alignment accuracy at all listening positions.

Sculpted to blend with the new form, and increase structural integrity, the midrange enclosure alignment bridge better reinforces the module external frame and is a more massive construction using a combination of X-Material and aluminum. A delicate balance is formed within the lines of Alexia V. In some areas mass was increased while in others material was removed. The cutout that reduces unwanted pressure between the midrange and woofer enclosures found on the top of the Sasha DAW woofer blades is now a part of Alexia V. The more aerodynamic looking tweeter module has been reshaped to comfortably house the larger Convergent Synergy Carbon tweeter.

## Transducers

First introduced in the Alexx V, Wilson's Convergent Synergy Carbon (CSC) Tweeter now finds a place in the Alexia V. This unique and complex carbon fiber rear-wave chamber is constructed entirely in-house on one of our many dedicated 3D printers. Listening to the results of this special tweeter, one can't help but get lost in its ability to present an unprecedented level of ambient retrieval and exceptional harmonic expression.

The integration of the tweeter and midrange is an absolutely critical element to accurate sound reproduction. Originally, when Alexia Series 2 was introduced, it utilized the same cellulose fiber/carbon composite midrange unit as is found in the WAMM Master Chronosonic. This midrange has served Alexia well over the years. After extensive experimentation and system refinements the Alnico (Aluminum-Nickel-Cobalt) QuadraMag has been successfully incorporated into the design and selected as the main midrange for the Alexia V. First developed for the Chronosonic XVX, the QuadraMag midrange provides a tonally rich and life-like sound.



## Signal Path

Every custom capacitor used in both Alexia V's crossovers has been wound and finished at Wilson Audio's in-house capacitor manufacturing department (Reliable Capacitors). These unique capacitors are made to industry leading tight tolerances. The AudioCapX-WA capacitors, along with fine-tuning in the crossover topology, have contributed to a new standard in loudspeaker low level resolution.

Modifications made in the crossover slightly improved the impedance measurement of 2.59 ohms at 84 Hz from 2.54 ohms. Alexia V's sensitivity measurement has also improved by +1dB over that found in Alexia Series 2.

Wilson Audio's bespoke binding posts create a cleaner signal path at its point of contact. Both banana plug and traditional spade connections can be used with this binding post. Additionally, the new spades, previously only found on the Chronosonic XVX and Alexx V, are optimized to couple precisely with the binding posts. New custom built cables connecting everything inside Alexia V provides a balanced and beautiful sounding signal path.



## Excellence in all Things

Wilson Audio's engineering team is always evaluating and refining major hardware components in the search for breakthroughs that serve the music. A few more of the upgrades found in Alexia V:

- Included with Alexia V is a complete set of Wilson Audio Acoustic Diode. An all-new spike system launched with Alexx V, which has been completely upgraded from our standard spike system, and features a novel combination of austenitic stainless steel and V-Material. This coupling system was created by Wilson Audio's Special Applications Engineering (WASAE) division and has superlative vibration management that reveals far greater dynamic nuances across the entire frequency spectrum.
- Resistor mounting hardware is now attached to carbon fiber and angled in such a way for a more beautiful presentation and ease to work with.
- The improved and aesthetically appealing external cable dressing solution.
- A new stylized alignment "staircase" block has been developed for ease of visibility during installation.
- The woofer port has been improved to increase laminar flow.
- Mid enclosure internal volume was increased 6.4% to allow a more open sounding midrange. The woofer enclosure internal volume is now 8.9% larger compared with Alexia Series 2 creating deeper low frequency reproduction and faster transient settling.
- Refined internal midrange wave diffusers allow faster midrange settling.
- There is now an integrated Bubble Level on the top of the woofer cabinet which makes leveling the loudspeaker much easier and more convenient.







## Specifications

**Enclosure Type Woofer:** Rear Ported

**Enclosure Type Midrange:** Rear Vented

**Enclosure Type Tweeter:** Sealed

**Woofers:** One—8 inches (20.32 cm)

One—10 inches (25.4 cm)

**Midrange:** One—7 inches (17.78 cm)

**Tweeter:** One—1 inch (2.54 cm)

**Sensitivity:** 90 dB @ 1 Watt @ 1 Meter @ 1 kHz

**Nominal Impedance:** 4 ohms / minimum 2.59 ohms @ 84 Hz

**Minimum Amplifier Power:** 20 Watts per channel

**Frequency Response:** 19 Hz – 33 kHz +/- 3 dB Room Average Response [RAR]

**Overall Dimensions:** Height—50 15/16 inches (129.42 cm) w/o spikes

Width—15 3/4 inches (40.01 cm)

Depth—24 3/16 inches (61.41 cm)

**System Weight Per Channel (uncrated):** 265 lbs each (120.20 kg)

**Total System Shipping Weight (approx.):** 795 lbs pair (360.61 kg)



# ALEXX V<sup>®</sup>

*“The Alexx V is distinguished not by any special warmth, approachability, or friendly coloration but, rather, by its evenness and consistency of tone, its ability to excavate detail effortlessly and without emphasis, and its clarity, accuracy, and naturalness of musical expression.”*

*Jim Austin, Stereophile*

AUTHENTIC EXCELLENCE



## About Alexx V

When it came time to upgrade the Alexx, Daryl Wilson wanted to be sensitive to where research and development had brought Wilson Audio over the past five years. The decision was made that a fresh look at the Alexx was in order, so Wilson Audio's R&D team approached the Alexx V as if it were an all-new loudspeaker. They took elements that clearly worked in the original design and began to apply the myriad of technologies generated by Wilson's R&D since the advent of the Alexx. Following major launches of the WAMM Master Chronosonic, Chronosonic XVX, Sasha DAW, and SabrinaX, Alexx V joins a very special family of groundbreaking loudspeakers designed and handcrafted especially for music lovers and audiophiles alike.

The original Alexx loudspeaker, launched in 2016, quickly gained critical acclaim throughout the industry. Alexx benefited from several elements developed during the five years Wilson Audio's founder David A. Wilson, and his unwavering R&D team, brought to life his magnum opus: the WAMM Master Chronosonic. Now, five years after the monumental accomplishment of the WAMM, Alexx V builds upon the original Alexx's success by offering a completely re-engineered performance envelope without greatly increasing the footprint. Comparing the overall size of Alexx V to the original, Alexx V is only 1" deeper and 1" taller while maintaining the same width.

Each and every component of Alexx V has been re-evaluated and significantly improved. The launch of Alexx V represents a cumulative approach to loudspeaker design, something that Wilson Audio has been steadfast about integrating since the very first location monitor that Dave built almost five decades ago. Incorporating the latest technologies, engineering efficiencies, and material sciences, Alexx V has improved upon the original Alexx by giving, yet again, a higher level of resolution (both temporally and audibly). Finally, Alexx V incorporates Wilson Audio's latest design language which started with the WAMM Master Chronosonic. The open gantry design not only allows for more structural rigidity and setup flexibility, it also provides a more free flowing organic look and emotionally expressive sound.



## Drivers

Continuing the Midrange – Tweeter – Midrange (MTM) design geometry of the original Alexx, our engineering team has spent considerable time advancing key components of the loudspeaker's sound characteristics. Every baffle angle, at every module position, has been refined. The time-alignment accuracy of Alexx V is much closer to the XVX, giving this system the ability to recreate micro-detail one would expect from a much larger system.

The different sized lower and upper midrange drivers allow for a more careful tuning of the frequency band, which, when combined with the latest manufacturing advances, gives a greater degree of accuracy and adjustability. The incredibly fast and resolving 5.75" mid-woofer used in the original Alexx, TuneTot, and SabrinaX, carries over for Alexx V. With the midrange band managed by two dissimilar sized drivers we opted to leverage the incredible advances of our Alnico (Aluminum, Nickel, Cobalt) QuadraMag design. This 7" mid was originally developed for XVX Chronosonic and has a warmth, beauty, and texture that brings to life all the elements in your favorite recordings. The QuadraMag driver combines four separate magnets, arranged in an innovative quadrature geometry, further enhancing the delicate intricacies of the all-critical midrange reproduction quality.

Behind the midrange drivers, internal wave diffusers have been integrated to further aid the resolving power by dramatically increasing the settling speed of the system. This creates a more life-like reproduction of midrange tone, expression, and accuracy in these remarkable midrange drivers.

When it came to the tweeter, the R&D team once again considered all available options. Fundamentally, the integration of the tweeter and midrange is an absolutely critical element to sound reproduction. Countless hours were spent examining areas of improvement. After careful and methodical consideration, the R&D team decided to build an all-new tweeter system. Therefore, Alexx V features an entirely new Convergent Synergy Carbon (CSC) tweeter, which builds upon a modified version of the previous Convergent Synergy motor while embracing an outstanding and intricately innovative rear-wave chamber. This all carbon fiber design is completely manufactured in-house using several 3D printers. The sonic results of this tweeter development cycle have been nothing short of dramatic. The CSC offers far greater and more linear high frequency extension while providing unprecedented ambient retrieval and superior harmonic detail.



Wilson Audio originally developed the 10.5" and 12.5" woofers in conjunction with the WAMM Master Chronosonic. These state-of-the-art bass drivers incorporate Wilson Audio's latest thinking into accurate and musical low frequency reproduction. Carefully optimizing the Alexx V enclosure, the internal volume has dramatically increased by sixteen percent compared to the original Alexx. The net result is that Alexx V features almost the same internal woofer volume as the Chronosonic XVX, which in turn allows for much deeper low frequency reproduction, faster transient settling, and an overall increase in bass resolution.

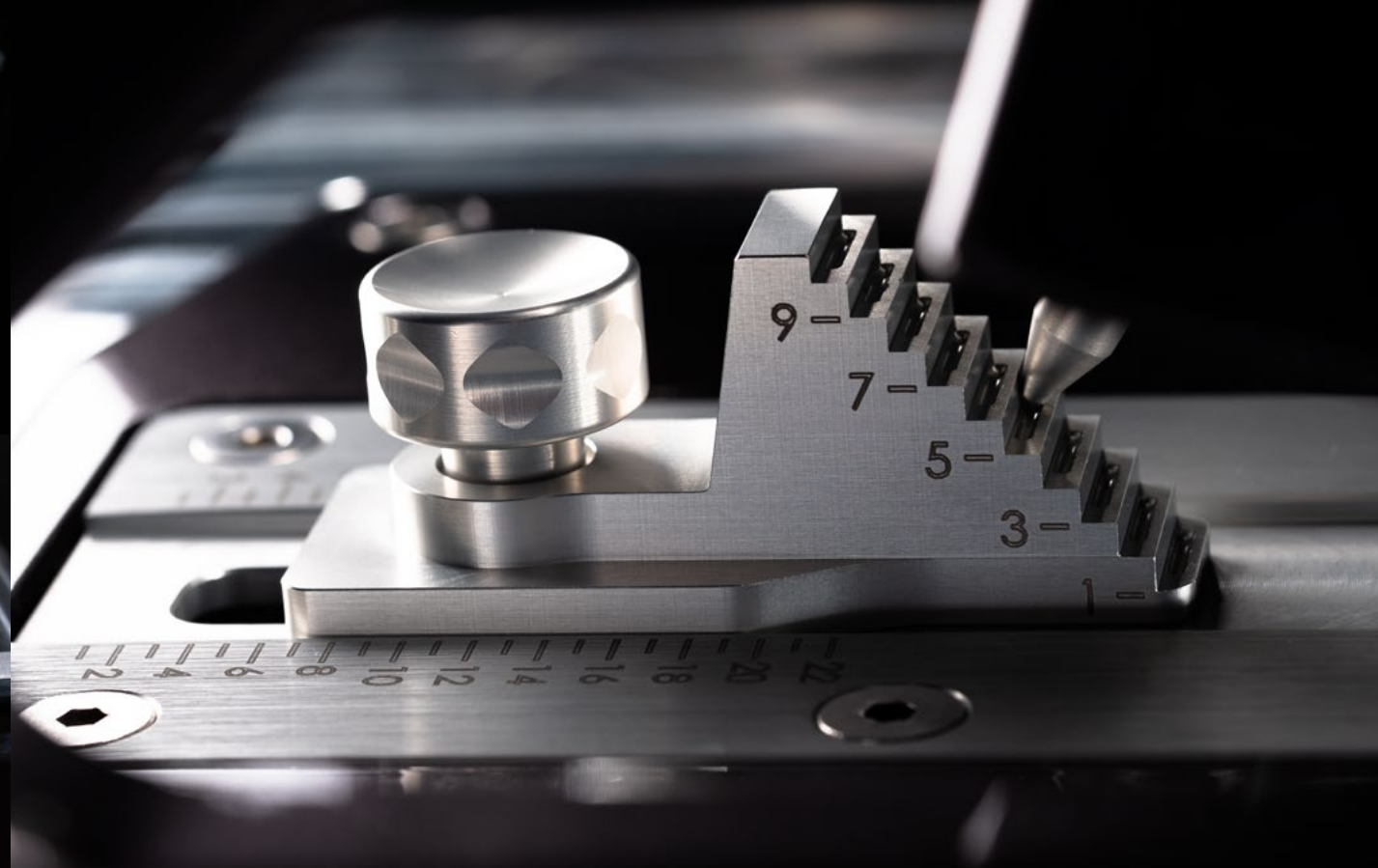
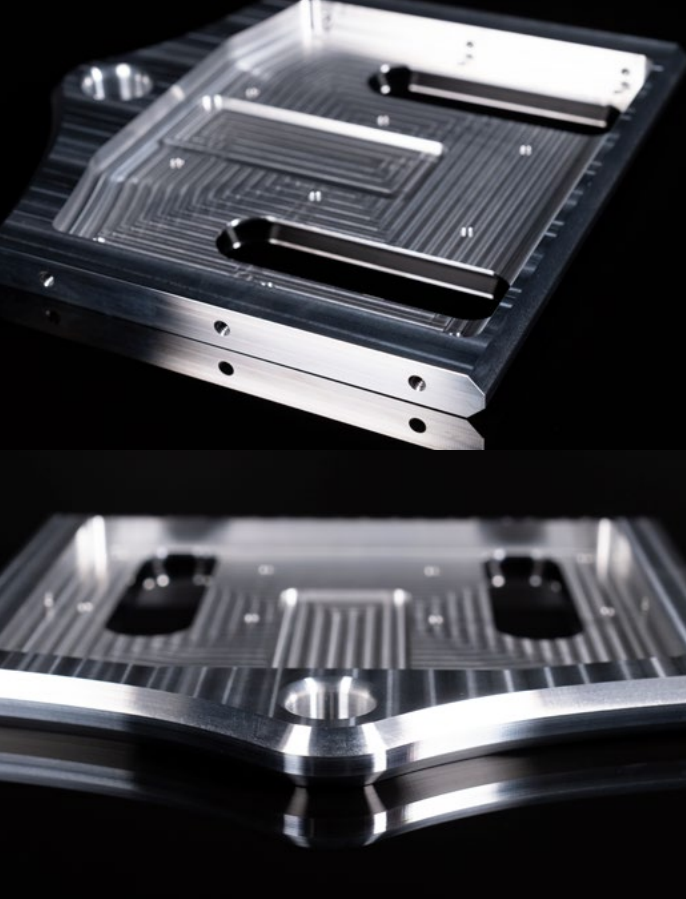

## Adaptable

Alexx V is an extraordinarily adaptable design. Carrying over elements from its larger siblings, such as the XLF reversible woofer port and independently adjustable modules, allow this system to be elegantly tailored to your listening room.

The open architecture gantry first launched with WAMM Master Chronosonic, followed by Chronosonic XVX, has now found a home with Alexx V. Not only does this benefit the overall appearance of the loudspeaker, but critically, it also enhances the overall rigidity of the entire upper module section and minimizes pressure trapped behind the enclosures, resulting in greater fidelity. Easier access to the upper modules makes for quicker adjustments. Similar to our innovative lighting solution (Sono 1™ from Coolfall®) featured in Chronosonic XVX, Alexx V has an illuminated cross brace at the rear of the gantry which aides in speaker module setup and time-alignment fine tuning.

## Materials

A variety of carefully chosen materials have been implemented in this distilled design. The latest version of X-Material, extremely monotonic and damped in its response, is found throughout the woofer, gantry, and upper modules. S-Material is tightly coupled to each midrange and provides a neutral and natural surface from which music can launch. First used in the Chronosonic XVX, our latest and most remarkable sound-vortex V-Material is strategically nested into interface locations for superior vibration control. V-Material behaves like a vibration absorber and has been put in the structure between the woofer module and the gantry. V-Material can also be found in our new, carefully engineered, and high performing Wilson Audio Acoustic Diode spike system. X, S, and V-Material, combined with carbon fiber, austenitic stainless steel, and aerospace grade aluminum, are artistically and judiciously blended to make cutting-edge audio and industrial art.



## Hardware

Considerable time and analysis have been spent on redefining and upgrading various key hardware components of Alexx V. Our engineering team went through each of the critical sub-systems and upgraded or reengineered many of its components:

- Introducing the Wilson Audio Acoustic Diode. An all-new spike system launched with Alexx V, which has been completely upgraded from our standard spike system, and features a novel combination of austenitic stainless steel and V-Material. This coupling system was created by Wilson Audio's Special Applications Engineering (WASAE) division and has superlative vibration management that reveals far greater dynamic nuances across the entire frequency spectrum.
- The custom built Wilson Audio binding posts, first appearing in Sasha DAW, have now also been integrated into Alexx V. Both banana plug termination and traditional spade connections can be used with this binding post. This premier binding post offers a clean signal path with an upgraded contact surface area.
- First pioneered with WAMM Master Chronosonic, Alexx V features our latest cable management system. Aiding not only the overall visual aesthetic of the speaker's rearward look, this cable management system offers an altogether superior solution to achieving the perfect length of speaker cable for each of the upper modules as they are adjusted for correct time-alignment.
- Gold lugs, which are a superior electrical conductor, are featured throughout the entire product. Some places they can be found are within the crossover, connector plate contact points, and resistor connections.
- Given the open architecture gantry design, the gantry grilles are seamlessly attached via embedded magnets, allowing for quick and simple installation and removal.





## Specifications

**Enclosure Type Woofer:** XLF Port, Adjustable Rear or Front Firing

**Enclosure Type Midrange:** Lower: Rear Vented / Upper: Rear Vented

**Enclosure Type Tweeter:** Sealed

**Woofers:** One—10 1/2 inches (26.67 cm)

One—12 1/2 inches (31.75 cm)

**Midrange:** One—7 inches (17.78 cm)

One—5 3/4 inches (14.61 cm)

**Tweeter:** One—1 inch (2.54 cm)

**Sensitivity:** 92 dB @ 1 Watt @ 1 Meter @ 1 kHz

**Nominal Impedance:** 4 ohms / minimum 2.0 ohms @ 250 Hz

**Minimum Amplifier Power:** 50 Watts per channel

**Frequency Response:** 20 Hz – 32 kHz +/- 3 dB Room Average Response [RAR]

**Overall Dimensions:** Height—63 5/16 inches (161 cm) w/o spikes

Width—15 3/4 inches (40 cm)

Depth—27 29/32 inches (70.88 cm)

**System Weight Per Channel (uncrated):** 500 lbs each (226.80 kg)

**Total System Shipping Weight (approx.):** 1,400 lbs pair (635.03 kg)



# CHRONOSONIC<sup>®</sup>

---

## XVX

*"I've lived with many, many of the world's greatest loudspeakers in my home, and heard countless others at shows, but I've never heard a speaker quite like the Chronosonic XVX. It is the most realistic sounding, the most musically expressive, and the most intellectually and emotionally engaging loudspeaker I've heard."*

Robert Harley, *The Absolute Sound*

*"Silence is very important. The silence between the notes is as important as the notes themselves."*

Wolfgang Amadeus Mozart

AUTHENTIC EXCELLENCE



## The Intersection of Legacy and Technical Innovation

In late 2012, Dave Wilson began work on a new WAMM. His goal was a reference loudspeaker that would not merely be worthy of its namesake—Dave's industry-changing WAMM from the early 80s—but would redefine the idea of what was possible in music reproduction. His goal was nothing short of a laboratory-grade loudspeaker that would pass a complex music signal through it with unprecedented accuracy. He knew the new model would challenge and test his company in new, potentially unforeseen ways. When he completed the design in 2016, Dave's Magnum Opus did more to raise the bar than any previous loudspeaker.

The cost-no-object WAMM Master Chronosonic will always remain as Dave's statement on music reproduction. From the outset, he understood and even stipulated that its production would be limited to a small number of pairs. For Daryl and all of us at Wilson Audio, each WAMM is a symbolic reminder of Dave's organizing passion—to categorically redefine the possibilities of music reproduction without any consideration of cost or practicality. Since he was a young child, Daryl has been immersed in this perfectionist culture. The central ideals of which played a significant role in molding his own uncompromising principles and standards.

It should come as no surprise that when the time was right, Daryl began design work for his own statement loudspeaker. In 2017, he knew it was time to push his and his engineering team's skills, passion, and expertise to further limits and extremes—just as his father had with the WAMM. From this inchoate desire, he began formulating ideas for his new flagship loudspeaker. Ideas that launched an unprecedented wave of research and innovation within his design, engineering, and manufacturing teams. The fruits of this intensity have now culminated in a new category of loudspeaker, one that sits comfortably alongside his father's masterpiece.



## Wilson's New Midrange: The Alnico QuadraMag

The sound of unamplified, live music has always driven the development of Wilson's drivers. Just as Wilson's current midrange driver finds its origins in the great concert halls of the world (chief among them the Musikverein in Vienna, Austria), the new Wilson midrange driver's development was fueled by a passion for the authentic reproduction and emotional experience of live music.

Since early in his career, Dave Wilson was attracted to the natural beauty exhibited by many drivers using Alnico magnets. However, the existing crop of Alnico drivers fell well short of Wilson's current proprietary midrange driver. His research surrounded this question: Could a driver combine all the virtues of Alnico magnets in a design that also offered the extreme resolution and dynamic expression of Wilson's benchmark midrange driver?

The first Alnico prototype was co-developed by Dave (his last design project) and Vern Credille. From this platform of Dave's original quest, Daryl and Vern continued experiments and research. The outgrowth of more than a year of research and development, Wilson's QuadraMag driver is the answer to Dave's original question.

Wilson's new mid combines all the warmth and natural timbre of classic Alnico magnet formulation in a thoroughly modern design. The QuadraMag midrange unit combines Alnico magnets in an entirely re-imagined "quadrature" geometry. This midrange driver brings together unparalleled natural beauty, harmonic integrity, musicality, low distortion, and ultra-high resolution in a single design. It possesses a distinctive admixture of musical and technical virtues heretofore unrealized with any other previous design.

## Myriad Details

The format of the flagship loudspeaker fits Daryl Wilson's attitudes and convictions perfectly. He is extraordinarily compromise-averse. Removing any constraints of price or practicality within the design equation felt liberating to Daryl. If Daryl had one advantage his father lacked, it was the WAMM itself. Some of the technology developed for the WAMM now resides in the Chronosonic XVX in a simpler form. More than in any other previous loudspeaker, Wilson introduced more technology, features, and manufacturing processes in the Chronosonic XVX.

Some examples: A new, fully integrated lighting system aids critical setup of the Chronosonic XVX's time-domain array. When designing this portion of the upper Gantry, Daryl and Jarom turned to American lighting experts Coolfall, the world's leading manufacturer of exotic custom flashlights. The custom system, designed in collaboration with Dave Livingston, owner of Coolfall, incorporates a precision solution for broad-gamut lighting during the critical adjustment of the complex time-domain mechanisms.

The crossover housing is now constructed from carbon fiber. An all-new Wilson-designed connecting spades now join Wilson's proprietary binding posts as a unified connection system. The quick-release time-domain adjustment bolts first developed for the Sasha DAW are utilized in the XVX.

The tuning and protection resistors are located on an easily accessible portion of the rear cabinet. Each is mounted to a carbon fiber substrate. Changing resistors is a simple matter of removing a quick-release glass cover and removing the hardware from the heatsinks.

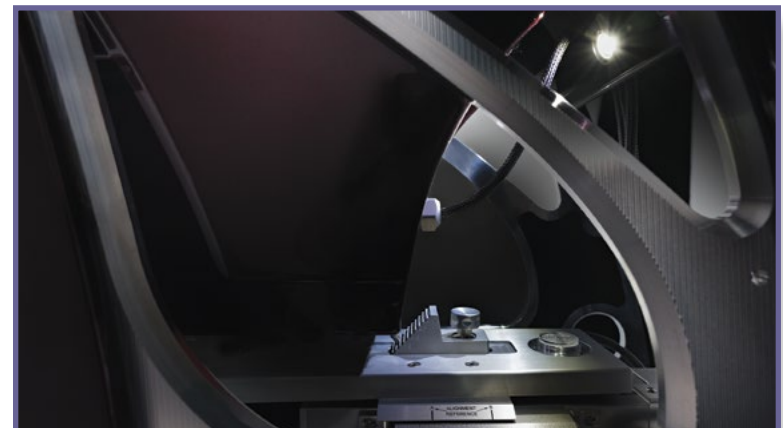

## Driver Technology

Wilson Audio originally developed the ten and twelve-inch woofers appearing in Chronosonic XVX in conjunction with the WAMM project. From the outset, Vern Credille designed the two woofers from the ground up to complement each other. He individually optimized the drivers for speed, extension, low distortion, and authority. Chronosonic XVX's woofers' design and construction are the most advanced ever to be deployed in a Wilson loudspeaker. The volume-optimized, ultra-low resonance woofer enclosure provides the perfect platform for these state-of-the-art bass drivers. The sum total of all these elements work together to establish a new benchmark for bottom octave extension, musicality, and accuracy—bass performance in the same league as the WAMM.



As is true for the WAMM and the Alexx V, the Chronosonic XVX utilizes two optimized drivers to cover the critical midrange. The aforementioned QuadraMag seven-inch driver handles the lower midrange, and a new four-inch driver handles the upper mids. The four-inch is a modified version of the same driver

that first appeared in the WAMM Master Chronosonic. It covers the area up to the point where it seamlessly crosses over to the Convergent Synergy MK5 Tweeter.

The original Convergent Synergy was a benchmark of high-frequency beauty and ultra-high resolution. Since its introduction, Daryl has continued to refine and improve its performance. The MK5 version works seamlessly with the XVX's two-way midrange design. The rear-firing ambiance tweeter is also a Convergent Synergy MK5 unit. For the first time, it is possible to adjust the rear-firing tweeter within a range of 0dB to minus 37dB, facilitating additional fine tuning for each installation.



## Wilson-Made AudioCapX Capacitors

Wilson Audio moved its capacitor design and production in-house at the end of 2018. This critical move has given Wilson an unprecedented level of quality control with all the capacitors used in product crossovers. The already industry-leading crossover-to-crossover consistency has now reached new heights. Wilson has long been the leader for ultra-tight tolerances in its crossovers, combining the best components available with extremely meticulous execution and testing. Since its inception nearly a year ago, our new division resides at the pinnacle of innovative capacitor technology and empirical (music-centric) development. Within the Chronosonic XVX's crossover, Wilson debuts the all-new AudioCapX-WA (application-specific, bespoke versions of our AudioCapX). AudioCapX-WA capacitors advance the already state-of-the-art harmonic beauty and low noise floor within Wilson's crossovers—and simplify the method for even tighter tolerances.



## Cross-Load Flow Port (XLF)

As most audiophiles have experienced, various architectural details within a home affect the way a loudspeaker loads bass into the room. In homes featuring several large windows, for example, a loudspeaker with otherwise excellent bass performance can sound lean. Dave Wilson originally conceived of the Cross-Load Firing Port as an effective remedy for this real-world problem. An elegantly simple idea, the Cross-Load system allows the user to choose either a front or rear-firing port configuration. On the front of the XVX, below the woofers, a plate covers a plug for that (one-of-two) port. The port in this configuration is on the rear of the bass enclosure. In rooms where the rear-firing option would tend to overload the bass, it is merely a matter of removing the plate and port plug, switching those items to the rear, and attaching the low-turbulence trim to the front, moving the port exit to the front of the Chronosonic XVX.



## Precision in Time

When developing the WAMM, the ultra-precise and minute adjustment of the modules in the time domain required more time and resources than any other single element. After more than a year of engineering time, Wilson completed the WAMM Master Chronosonic Micrometer system—a mechanism that facilitated the exact movement of the critical elements within the array. Like the WAMM, the goal for XVX's time-domain accuracy was to approach the theoretical ideal, with adjustment increments in the two-millionths-of-a-second range with greater ease and simplicity.

The Chronosonic XVX time-domain array includes two Micrometer units—one for the upper QuadraMag driver and the Convergent Synergy tweeter submodule, the other for the second QuadraMag and the 4" midrange. In turn, each of those modules is individually adjustable within the array. This complex mechanism resides at the heart of the Chronosonic XVX's exceptional time-domain accuracy and facilitates the loudspeaker's optimization for nearly any soundroom and listening geometry. Only the WAMM matches the XVX's real-world time-domain accuracy, which in most rooms deviates less than 5-millionths-of-a-second driver to driver.

The technology would be academic were it not for the extraordinary musical results it provides. Transient speed is increased as a direct result of waveforms that are properly aligned at the listening position. But perhaps more important is the lack of time-domain noise between the transients—the silence between the notes is revealed. It is this ability that most accounts for the XVX's uncanny realism and emotional fluency.

In the end, all aspects of music are improved: harmonic expression, spatial resolution, micro detail, and spatial retrieval are greatly enhanced with time-domain accuracy.

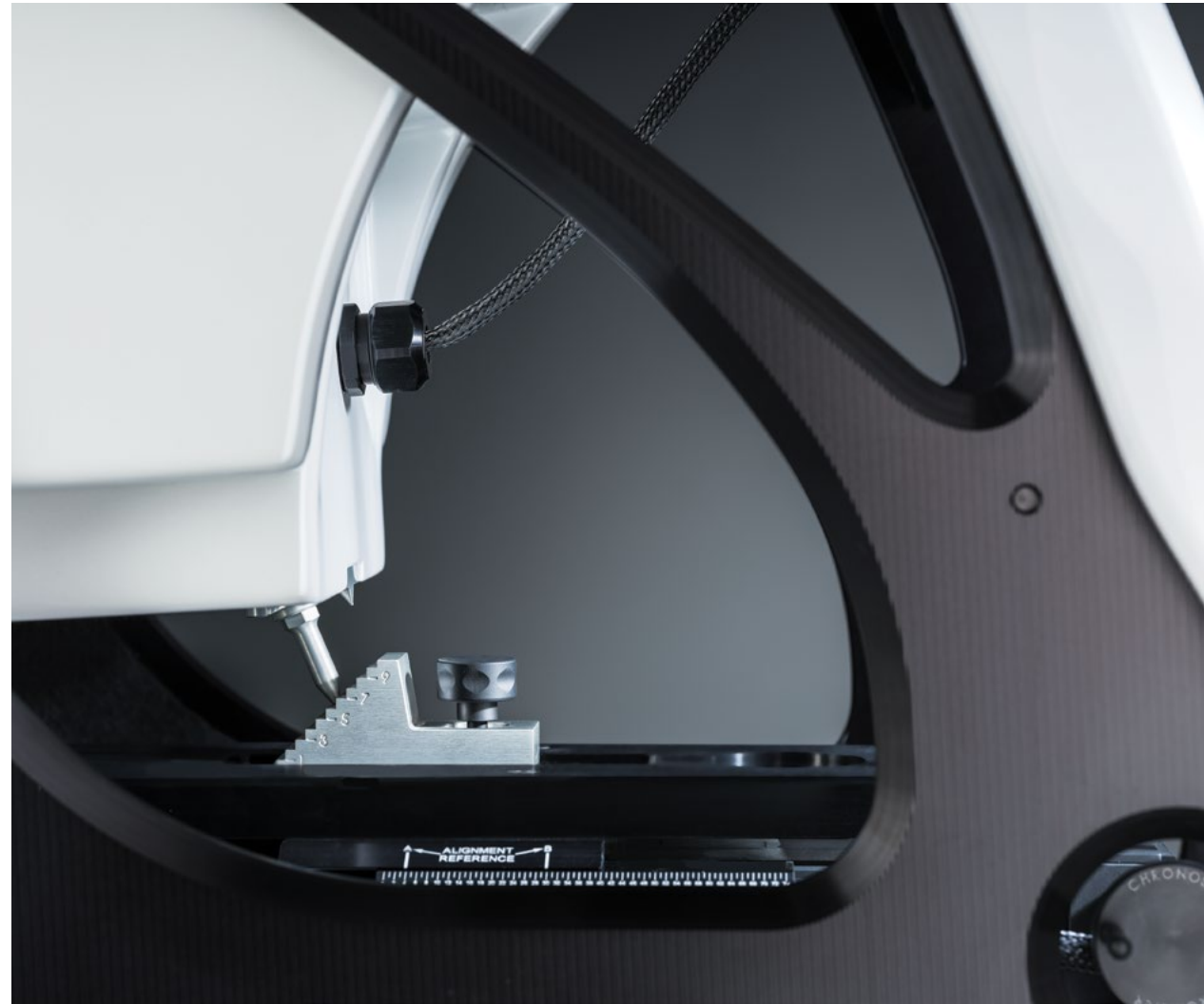



## MTMM Upper Array Geometry

The Chronosonic XVX Gantry is configured using an unusual MTMM (midrange, tweeter, midrange, midrange) arrangement. Wilson's engineers further refined and perfected the proprietary two-way midrange system first developed in the WAMM and utilized in a simplified form in the Alexx V. The all-new QuadraMag driver joins forces with a modified and enhanced version of the 4" midrange from the WAMM to form the lower section of the MTMM. A second QuadraMag midrange driver at the top of the Gantry flanks a Convergent Synergy MK5 tweeter, completing the MTMM geometry.

Construction of the Gantry of the XVX is accomplished via an open-architecture system constructed from X-Material reinforced, ultra-high-grade aluminum. The Gantry's primary function is to provide an extremely rigid architecture for all the moving elements and modules that enable the system's accurately adjustable time-domain. Special attention was paid to the triangulated cross bracing and the strategic use of X-Material composites in an effort to improve both rigidity and critical damping. The new scalloped finish on the aluminum elements is both beautiful and functional, acting as a diffuser to further minimize the XVX's sonic signature within the room. A new magnet system secures the decorative Gantry grille covers, which enables quick and easy attachment or removal of the grille for service or listening.



## Enclosure Materials

Most loudspeaker manufacturers are content with building enclosures from medium-density fiberboard (MDF)—a material originally used in the construction of tract-home sub floors. In contrast, Wilson has spent close to 50 years researching and developing cutting-edge composites. It's fair to suggest that Wilson's success in addressing the deleterious effects of inadequate enclosure materials has started a marketing fad. It's become *de rigueur* for high-end loudspeaker manufacturers to tout their newest material of choice. However, the clear majority of these market-driven efforts are intrinsically one-dimensional. Most loudspeaker designers typically focus on a single material, whether it is some pet grade of aluminum or the trend in carbon fiber. Materials research into the actual factors that improve musicality has been a key focus of Wilson's ongoing efforts to push the envelope of loudspeaker performance for decades. Wilson's materials-research facility is equipped with cutting-edge tools, including technology in the area of Laser Doppler Vibrometry. This aerospace testing tool allows Wilson's engineers to observe and correct cabinet vibrations at the level of nanometers (one-billionth of a meter).



## X-Material

The third generation of X-Material has its roots in its namesake: The X-1 Grand SLAMM. But this version of X is also a beneficiary of Wilson's ongoing materials research. X is a material that at first seems paradoxical, but is in reality the result of decades of research into those areas of loudspeaker-enclosure science that truly contribute to musical veracity. No other material possesses its (seemingly contradictory) combination of extreme rigidity, monotonicity, modulus of elasticity, and intrinsic damping. X-Material is strategically utilized throughout the Chronosonic XVX's enclosure, and is central to an unprecedented effort to reduce enclosure-born colorations to historical lows.

Wilson learned long ago that no enclosure material is ideal for all applications. This understanding—seemingly unique to Wilson Audio—has led to the development of other materials optimized in the areas for which X-Material is less than absolutely ideal.

## S-Material

The research surrounding the Sasha W/P led to the development of S-Material, which is used in all of the midrange baffles. S is similar to X in its damping characteristics, but has been engineered for the unique demands of the musically critical midrange drivers.

## V-Material

Wilson Audio's newest composite technology—V-Material—is the newest product of Wilson Audio's intensive and ongoing materials research. V-Material charts new territory with its unprecedented ability to dampen vibrations (it turns vibrations into heat with unparalleled rapidity). V was named for the Chronosonic X"V"X for which it was developed. V's intrinsic silence makes it perfect for certain applications. In the Chronosonic XVX, it is positioned in the sub-plate of the Micrometer bed—the module transfer point in the Gantry superstructure—to optimize the upper modules' coupling to the cabinet. It also forms the platform upon which the entire Gantry rests.





# CHRONOSONIC<sup>®</sup> *4 Seasons* XVX



In 2022 Wilson Audio announced a limited XVX series that paid homage to the familiar and anticipated changes we see in nature every few months. This version is called the Chronosonic XVX 4 Seasons.

As with music, each of us is uniquely moved by the elements of the year. Utah is known for its alluring and beautifully distinct four seasons. Each season here in the high mountain desert dresses the landscape with gorgeous colors and creates stunning scenes to which millions come to admire and experience.

This aesthetically rare XVX series drew inspiration from the natural color combinations found in Utah and from the countless mountain ranges, sand dunes, meandering streams, lakes, and vistas.

With the unprecedented and universal embrace of our flagship, and the overwhelming praise published about Chronosonic XVX, our Special Applications Engineering team saw an opportunity to push the visual boundaries as much as we have pushed our uncompromising performance in the sonic realm.

Wilson Audio celebrated this remarkable journey with this special series. Chronosonic XVX 4 Seasons is where truly elegant and refined design harmoniously blends with the finest materials.

## A 2022 Exclusive Variant





## Specifications

**Enclosure Type Woofer:** XLF Port, Adjustable Rear or Front Firing

**Enclosure Type Midrange (7-inch):** Rear Vented

**Enclosure Type Midrange (4-inch):** Bottom Vented

**Enclosure Type Tweeter:** Sealed

**Woofers:** One—10 1/2 inches (26.67 cm)

One—12 1/2 inches (31.75 cm)

**Midrange:** Two—7 inches (17.78 cm)

One—4 inches (10.16 cm)

**Tweeter:** One—1 inch (2.54 cm)

**Rear Firing Tweeter:** One—1 inch (2.54 cm)

**Sensitivity:** 92dB @ 1Watt @ 1 Meter @ 1 kHz

**Nominal Impedance:** 4 ohms / minimum 1.6 ohms @ 326 Hz

**Minimum Amplifier Power:** 100 Watts per channel

**Frequency Response:** 20 Hz – 30 kHz +/- 2dB Room Average Response [RAR]

**Overall Dimensions:** Height—73 5/8 inches (187 cm) w/o spikes

Width—16 1/2 inches (42 cm)

Depth—33 inches (84 cm)

**System Weight Per Channel (uncrated):** 685 lbs each (310.71 kg)

**Total System Shipping Weight (approx.):** 1,695 lbs pair (768.84 kg)



WAMM<sup>®</sup>  
*Master*  
CHRONOSONIC



*“You, noble Art, in how many grey hours, when life’s mad tumult wraps around me, have you kindled my heart to warm love, have you transported me into a better world, transported into a better world! To my mind, this is what Dave Wilson has accomplished with the WAMM Master Chronosonic.”*

*Jacob Heilbrunn, The Absolute Sound*

AUTHENTIC EXCELLENCE



## Auspicious Beginnings

In the late seventies, Dave began experimenting with adjustable modular arrays. Empirical listening combined with careful measurements revealed that the ability to adjust the loudspeaker's drivers within the time domain—specifically as it related to aligning the leading edge transients of each of the individual drivers—was critically important. He realized that even tiny errors in the alignment of the drivers in relationship to the listener caused obvious sound-quality degradation. Through the late seventies and into the dawn of the eighties, he continued to explore these ideas, as well as modify and evolve his loudspeaker prototype. During this time, Dave applied for and acquired a patent for adjustable-propagation-delay loudspeaker arrays. More importantly, he continued to develop and refine his proprietary method for the accurate measurement of time-domain deviations.

By late 1981, his hard work had culminated in the form of his first assault on the state-of-the-art of believable music reproduction. He called his new loudspeaker the Wilson Audio Modular Monitor—the WAMM. The WAMM was a multi-module loudspeaker, each module physically adjustable in relationship to the other modules in the time domain. It was the physical manifestation of Dave's theories surrounding the lifelike recreation of music.

To call the original WAMM a breakthrough is an exercise in understatement.



## It's About Time

The measure of engineering success of any loudspeaker is its verisimilitude to acoustical (unamplified) music in a loudspeaker. There are two terms that describe the essential character of live music: Dynamic Contrast and Harmonic Expression. In order to achieve either of these, a loudspeaker must be correctly aligned in the time domain.

Most designers understand the importance of flat frequency response—accuracy in the spectral domain. Some also tout the importance of phase coherence, an aspect of music reproduction that blind empirical testing has shown to be less significant than accuracy in either the spectral or temporal domain. Seemingly, very few truly understand the importance of the time domain.

In addition to linear frequency response, preserving tonality and the complex textures of musical instruments requires the accurate preservation of Temporal Coherence. Subtle micro-timing clues, which are created by a variety of structures and spaces, are inextricable to the true nature of an instrument. It is the relationship of these overlapping waveforms in the time domain that produces an instrument's tonal signature. If accurate reproduction is the goal, it is vital that the timing relationships between these closely

spaced contributory sounds are preserved.

Ongoing research has confirmed that the ear/brain mechanism is much more sensitive to timing coincidence errors than once believed. Indeed, timing accuracy is as important as frequency response accuracy and far more important than phase coherence. Ordinary people can hear timing coincidence errors as small as ten-millionths of a second in the five to ten kHz octave. Most multi-driver speakers with fixed, flat baffles, positioned perpendicular to the floor, are incapable of correct alignment in the time domain on purely geometrical grounds. Most loudspeakers of this type introduce timing errors on the order of hundreds of microseconds at the listener's ear.

The Master Chronosonic is capable of driver-to-driver time-domain accuracy heretofore possible only in the theoretical domain. Via the Master Chronosonic Micrometer System, module movement is refined down to a previously inconceivable two microseconds (two-millionths of a second) per adjustment increment. The hallmark of the Master Chronosonic's technical achievement, and the principal factor central to its unique ability to sound utterly lifelike, is the Master Chronosonic Adjustable Array.



## Tweeter

In conjunction with WAMM and Alexx, Daryl Wilson and Wilson's team of engineers revisited the current state of the art of tweeter technology. The research included tweeter domes constructed of diamond and beryllium. After exhaustive testing and listening, Wilson's engineering team concluded that the silk-dome Convergent Synergy Tweeter remains the most musically authentic and emotionally satisfying tweeter yet tested. Yet again, Wilson's unique holistic approach to design was at play here—employing a combination of carefully conducted measurements and empirical listening. The Wilson-designed Convergent Synergy was further and specifically evolved and developed for the Master Chronosonic, and is designated as the MK5 version.



## Woofers

Unlike the original WAMM, which required a subwoofer to cover the bottom octaves, the Master Chronosonic is a true full-range design. In order to achieve Dave's design goals, it was decided that an all-new approach in the area of bass drivers was needed. The design imperative was to maximize transient integrity, speed, and bottom-octave extension. The all-new 10.5 and 12.5 inch woofers were designed from the ground up to complement each other, specifically addressing the challenges presented by using two woofers with different diameters in a single enclosure. These new woofers incorporate all of Wilson's cumulative on accurate and musical low-frequency music reproduction. The Master Chronosonic's heroic bass enclosure, with its unmatched ability to control and eliminate unwanted resonances, is the ideal platform in which to mount the Master Chronosonic's bass drivers.



## Midrange

Wilson's MTM configurations, which feature time-domain adjustability, have always been far more sophisticated, complex, and musical than competing designs. Rather than mounting the three drivers that make up the MTM in a flat baffle, each driver is mounted in its own module. The modules are, in turn, adjustable relative to each other, which facilitates alignment in the critical time domain within the loudspeaker array. Another advantage to modularity is the ability to optimize the construction of each module, with the specific combinations of composites best suited to the needs of each driver.

Led by Dave, Wilson Audio's engineering team re-imagined the MTM geometry for the Master Chronosonic. The midrange is divided between two drivers, a seven-inch and four-inch for both the bottom and top portions of the MTM array. Each of the two drivers cover a portion of the midband area. The seven-inch is a bespoke modified version of the celebrated Wilson mid, first introduced in the Alexandria Series 2. The four-inch is an eminently musical driver that covers the important upper-midrange area up to the point where it crosses over to the Convergent Synergy Tweeter. The frequencies covered by the two drivers are therefore both expanded upward and downward in frequency when compared to previous Wilson designs—the two together covering a broader portion of the midrange. Furthermore, each driver is optimized for the portion of the midband best suited to its unique strength. Dave masterfully blended the two sets of mid drivers, ensuring that they perform seamlessly and coherently together.





## Aerospace-Grade Aluminum

The infrastructural Gantry supporting the time-domain adjustability—the Master Chronosonic Micrometer—is constructed from aerospace-grade aluminum. One of aluminum's virtues is modulus of elasticity. This quality, combined with relatively low mass, resistance to corrosion, and low toxicity, make it an excellent material to form the adjustable support structure for the modules, ensuring that the overall rigidity of the module launch points is maintained. Because even the best aluminum is not well suited for driver interface or module damping, the Master Chronosonic employs Wilson's composites, X-, W-, and S-Materials in these locations.

The aluminum is finished in a beautiful prismatic machined pattern, calling to mind the Guilloché finish of the finest Swiss watches.



## Architectural Details

The woofer baffle is angled toward the upper array at 6.5 degrees, which improves the time alignment of the woofers in relationship to the listener's position. The open architecture of the Master Chronosonic's upper Gantry minimizes stored sonic energy behind the upper modules. The resistor-access panel features a new approach with improved access. The resistor heatsinks are custom built for the Master Chronosonic, each chosen for its combination of sonic and thermal performance.

Even the fabric grilles that optionally cover each of the module's drivers are hand-built using ultra-low-acoustical-impedance material.

The rear-firing module is optimized for ceiling heights normally found in domestic environments and increases

spatial retrieval and overall resolution. The tweeter was specifically designed for this application. It utilizes the rear wave chamber from the Convergent Synergy MK5 Tweeter. The 5" midrange was also specifically developed for this application.

A new system of cable dressing, which features rotary cable tensioners, makes its debut in the Master Chronosonic. While the new system is beautiful, the design was engineered to reduce the deleterious effects of magnetostriction. Similarly, custom-made enclosure-breach-point hardware, which terminates each corresponding cable into the rear of its respective enclosure, minimizes wire connection points throughout the loudspeaker system, and reduces degradation throughout the wired signal path.





## Unquenchable Curiosity

Dave Wilson was animated by an unquenchable curiosity, which, in turn, fueled his boundless yearning for discovery. He spent the better part of his adult life engaged in the difficult and demanding work of turning his intensely ambitious dreams into remarkable physical creations. He was obsessed with the sound of live music. Throughout his career, he always asked these important questions: Why do certain transducers sound more like the live musical event? What was it about certain combinations of cabinet materials, crossover elements, and drivers—and even the geometric arrangement of those drivers—that produced an intellectually convincing and emotionally satisfying facsimile of live music?

Somewhat unique in the high-end loudspeaker world, Dave was a natural scientist. He was dedicated to the rigorous application of the scientific method. Much of his success came from his ability to design testing protocols to best answer these questions. Dave understood that the veracity of any given theory was inextricably tied to the result it produced. Put simply, if it sounds real, the science is real.

## Specifications

**Enclosure Type Woofer:** XLF Port, Adjustable Rear or Front Firing

**Enclosure Type Midrange:** Bottom Vent

**Enclosure Type Tweeter:** Sealed

**Woofers:** One—10 1/2 inches (26.67 cm)

One—12 1/2 inches (31.75 cm)

**Lower Midrange:** Two—7 inches (17.78 cm)

**Upper Midrange:** Two—4 inches (10.16 cm)

**Main Tweeter:** One—1 inch (2.54 cm)

**Rear-Firing Tweeter:** One—1 inch (2.54 cm)

**Sensitivity:** 93.5 dB @ 1 Watt @ 1 Meter @ 1 kHz

**Nominal Impedance:** 3 ohms / minimum 1.77 ohms @ 310 Hz

**Minimum Amplifier Power:** 100 Watts per channel

**Frequency Response:** 20 Hz – 33 kHz +/- 2 dB Room Average Response [RAR]

**Overall Dimensions:** Height—84 3/8 inches (214.29 cm) w/o spikes

Width—21 inches (53.34 cm)

Depth—37 3/8 inches (94.87 cm)

**System Weight Per Channel (uncrated):** 900 lbs each (408.23 kg)

**Total System Shipping Weight (approx.):** 2,620 lbs pair (1,188.41 kg)







AUTHENTIC EXCELLENCE





*“How to shrink down an Yvette, a Sophia, an Alexia into something manageable for the space-shy? One can only imagine how many iterations preceded the final version, but Wilson Audio has succeeded in coming up with a mini-monitor that delivers 90% of the Wilson full range experience from 10% of the volume. If you want a no-compromise speaker smaller than a microwave oven, say hello to the TuneTots. Bravo!”*

*Ken Kessler, Hi-Fi News & Record Review*

AUTHENTIC EXCELLENCE





## The Smallest Wilson

Special Applications Engineering is a part of the founding DNA of Wilson Audio. The first product to fit that definition was the Wilson Audio Tiny Tot, or WATT. Long before it became the upper module of the venerable WATT/Puppy combo (the best-selling over \$10k loudspeaker in audio history), Dave Wilson utilized the WATT as a portable location monitor for the series of audiophile-quality records he engineered in the '80s and '90s. Recordings revered to this day, and currently available on the Wilson Audiophile label. Scan the QR Code to see the catalogue.



TuneTot is a product of Wilson's Special Applications Engineering (WASAE) team. While its name pays homage to the first WASAE product, it is a modern technical *tour de force* designed to offer the timbral beauty, dynamic nuance, soundstage resolution, and transparency—all the hallmarks of Wilson loudspeakers design culture—but do so in environments which are hostile to all of those qualities.

TuneTot is the smallest and least expensive Wilson, but it would be a mistake to see it as an "entry-level" offering. TuneTots are lovingly fabricated and assembled by the same group of talented craftsmen who build the WAMM Master Chronosonic, using exactly the same processes and techniques. Its cabinet and driver technology are derived directly from Alexx V and SabrinaX. Finally, each TuneTot that emerges from Wilson is held to the same rigorous, industry-leading manufacturing tolerances as its larger siblings, ensuring each TuneTot is as technically and musically accurate as the reference prototype. You hear precisely what Daryl Wilson heard in the final design.



## TuneTot and Time

From the inception of the first Wilson loudspeaker, it always has been understood that the time domain is a critical factor—if musical authenticity is the goal. With TuneTot, the challenge was twofold: Isolating the active loudspeaker from its environment and providing adjustable correction in the time domain. Wilson's engineers cleverly combined both needs into a single solution. Wilson provides precise yet simple installation setup instructions that allow TuneTot to be corrected in the time domain for each installation.

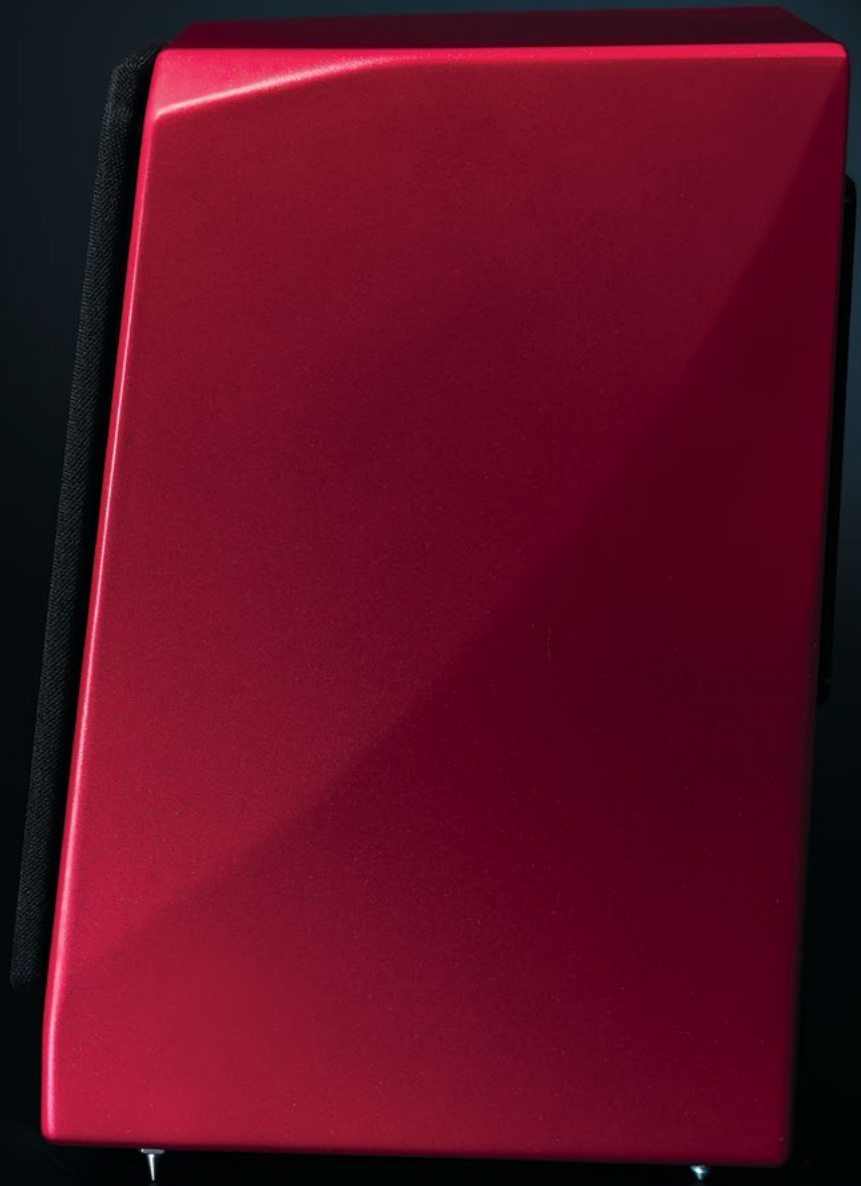

## An Enclosure Only Wilson Could Engineer

Composites have the advantage of being made up of several different constituencies, each of which can be uniquely optimized for a variety of design characteristics—such as acoustical damping and rigidity—performance factors that are mutually exclusive in single-element materials such as Aluminum or MDF. Just as is true for all Wilson's, TuneTot's enclosure was analyzed and reanalyzed using its state-of-the-art Laser Vibrometry system in order to optimize enclosure-wall thicknesses and the strategic implementation of the proprietary composites. With this precision instrument, WASAE engineers readily detect even the tiniest enclosure vibrations—at the level of billionths

of a meter, which, in turn, reveals the ideal combination and geometry of the composites for the cabinet. TuneTot is constructed from two Wilson proprietary composites—the proven combination of Wilson's X- and S-Material.

Wilson's engineers didn't stop there. Perfectly rectangular enclosures are inexpensive and easy to build but suffer from music-destroying internal reflections generated by parallel walls. TuneTot's enclosure is asymmetrical, ensuring no internal surface is parallel. Inspired by technology from the Alexia Series 2 and the WAMM, TuneTot's cabinet additionally features a complex internal reflection management system.

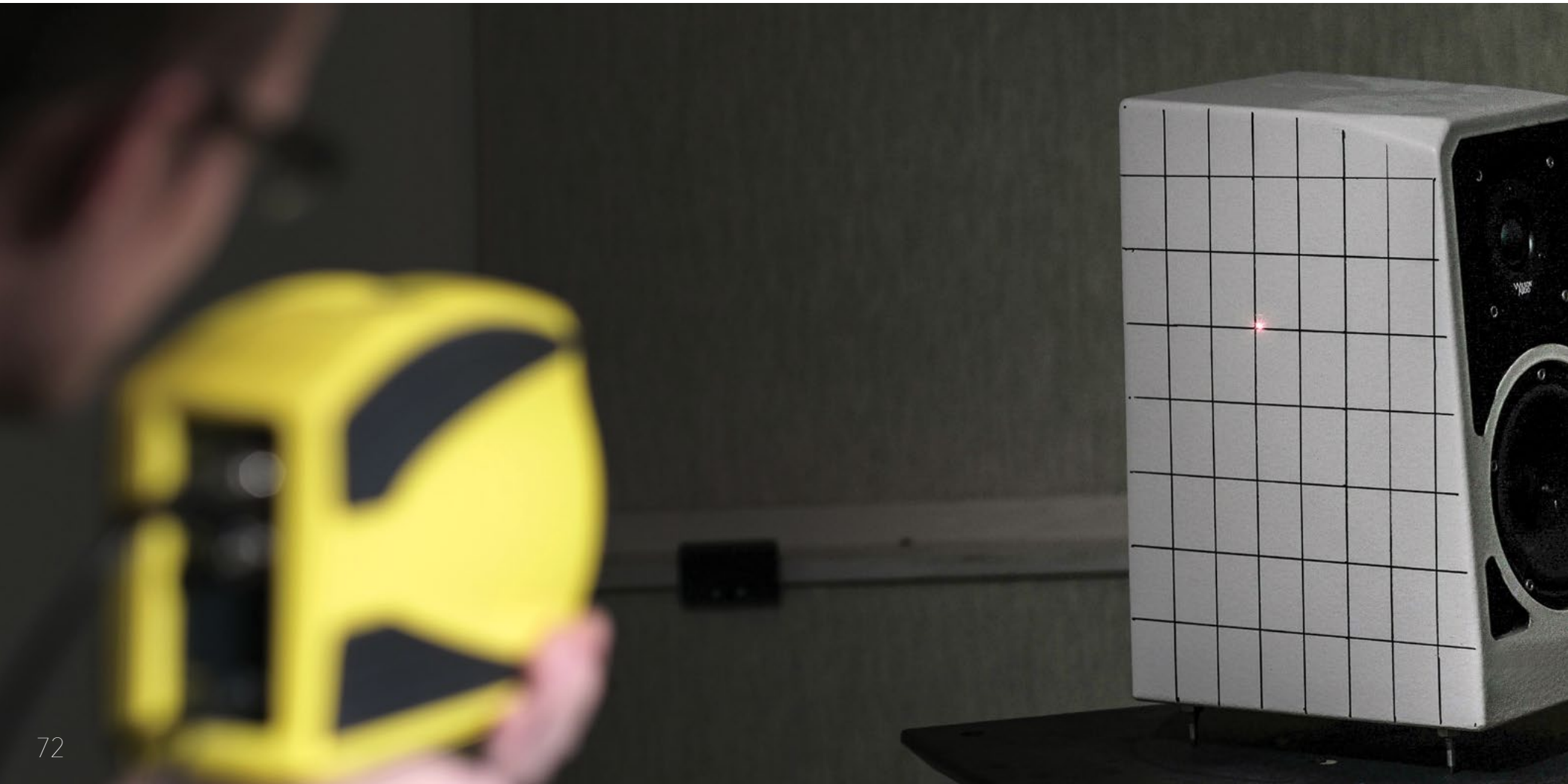

## Strategic by Design

Environmental music systems are increasingly part of contemporary lifestyles. Another ground-breaking Special Applications product, the Wilson Audio Duette, successfully addressed the challenges caused by near boundary placement.

Placing a loudspeaker on a desktop, bookshelf, counter top, or a credenza has meant accepting serious sonic compromises. Interactions and resonances from the furniture or shelf on which the loudspeaker rests are a source of audible distortion and colorations—deleterious factors most loudspeaker designers simply accept. The Wilson Way demanded a new look at the problem.

The Special Applications Engineering team spent months researching the interactions between TuneTot and the surface upon which it is installed. It quickly became clear that assumptions surrounding environmental resonance control needed to be re-examined. For these installations, the challenges presented are very different from what exists for a typical floor-standing loudspeaker spiked to the floor—problems that require a different strategy. A series of accessories were developed specifically to address furniture-born resonances endemic to these types of installations.

TuneTot is shipped with a set of leveling spikes. These devices allow the installer to obtain an optimal, time-domain-correct baffle angle in relation to the listener, but are also designed to provide some isolation between TuneTot and the surface below. One significant step further is the TuneTot ISOBase, an interim isolation platform which is placed between the loudspeaker and the surface below. The ISOBase offers unprecedented levels of decoupling and isolation between TuneTot and the structure upon which it rests.









## A New Ecosystem

More than just a loudspeaker, TuneTot is instead one element within an ecosystem populated with custom tools and accessories (purchased separately) designed to maximize its performance and cosmetic beauty in a wide variety of applications. The aforementioned ISOBase is the ideal solution for bookshelf, desktop, counter top, or credenza installations.

Many Wilson owners prefer to listen without the grille attached. For these installations, Wilson designed an optional aluminum ring, which covers the mounting hardware securing the woofers. The ring is individually milled and is beautifully finished in a choice of four anodized colors. For those listeners who prefer a grille, one is available for TuneTot. Its low diffraction frame is individually milled from solid billets of ultra-low-resonance X-Material. Acoustically transparent fabric (available in six colors) is meticulously hand stretched onto each composite frame. Lastly, a dust cover is available for those times when the TuneTots are not being used, protecting your loudspeaker from dust.

With the combination of available hardware, grilles, and paint color, TuneTot owners are able to custom configure their loudspeakers with just the right combination of performance options, paint color choice, and hardware and grille colors based on their individual aesthetic desire and installation needs.





## TuneTot Stand

Wilson's Special Applications Engineering division introduces the latest member of the TuneTot Ecosystem—the TuneTot Stand. The design team engineered it from the ground up to seamlessly augment TuneTot's beautiful lines. The primary design objectives were extraordinary stability and ultra-low resonance, and a platform that facilitated the proper alignment of the baffle for the time domain.

A custom-machined, solid billet of X-Material serves as the column riser. It is extremely inert and massive. X-Material, now in its third design iteration, is unique among composites for its remarkable combination of dampening characteristics and rigidity. The column is painted using our WilsonGloss process and is available in a range of colors to match or complement the TuneTot.

Optionally, the TuneTot Stand is configurable with the ISOBase, which further enhances resonant control. The ISOBase securely bolts to the TuneTot Stand. The combination of the Stand with the ISOBase provides a level of musical performance no other stand can match. Additionally, the ISOBase allows TuneTot's rake angle to be adjusted in relation to the listening position, which facilitates more accurate alignment of the time domain for most installations.

## Specifications

**Enclosure Type Mid-Woofers:** Rear Vented

**Mid-Woofers:** One—5 3/4 inches (14.61 cm)

**Tweeter:** One—1 inch (2.54 cm)

**Sensitivity:** 86 dB @ 1 Watt @ 1 Meter @ 1kHz

**Nominal Impedance:** 8 ohms / minimum 6.61 ohms @ 172 Hz

**Minimum Amplifier Power:** 25 Watts per channel

**Frequency Response:** 65 Hz – 23 kHz +/- 3 dB Room Average Response [RAR]

**Overall Dimensions:** Height—14 4/5 inches (37.59 cm) w/o spikes

Width—8 3/5 inches (21.84 cm)

Depth—10 1/5 inches (25.91 cm)

**System Weight Per Channel (uncrated):** 29 lbs each (13.15 kg)

**Total System Shipping Weight (approx.):** 70 lbs pair (31.75 kg)

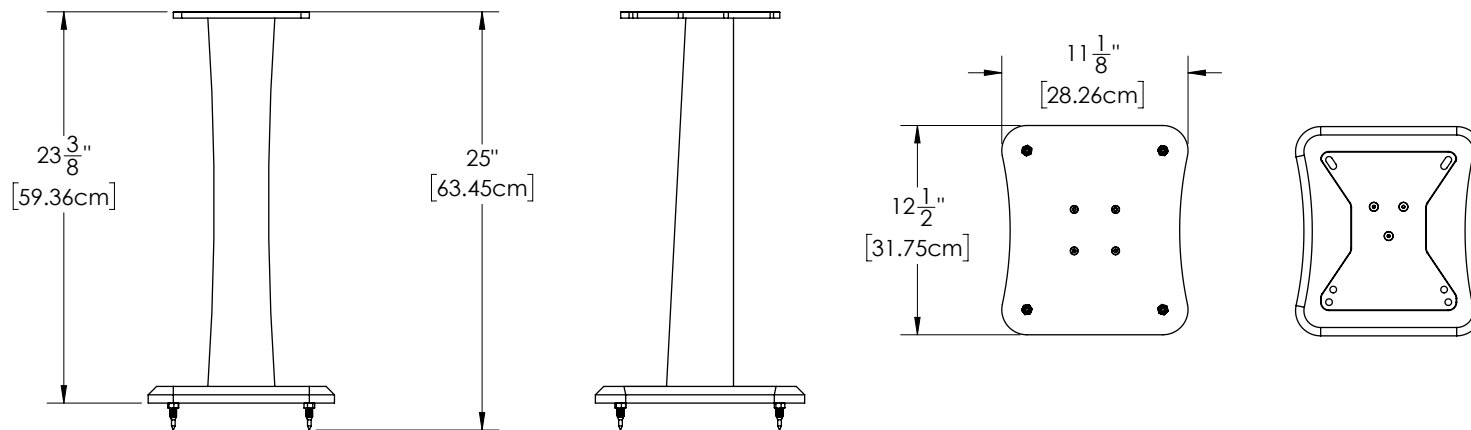







# ALIDA<sup>®</sup>

CONVERGENT SYNERGY

*“Alida was easily the choice for my twelve channel Atmos audio system. It’s small enough to put on the wall and ceiling, big enough to reproduce the full range of my music collection, and it blends with my other Wilson Audio speakers perfectly”*

*Chris Connaker, Audiophile Style*

AUTHENTIC EXCELLENCE



## The Evolution of a Surround Speaker Into the Definitive Wall-Mount

Wilson Audio's first wall-mount loudspeaker was designed as part of the WATCH Home Theater system. Its sole purpose was to serve as the surround sound component of a 5.1 installation while nonetheless offering the measure of frequency response and dynamic contrast that would complement Wilson's large floorstanding main speakers.

Over time, however, it became apparent that the performance of the WATCH Surround Speaker was so good that people were using it as wall-mounted speakers in two channel music systems. In bedrooms, offices, or other locations where space or architecture precluded the use of floor-standing loudspeakers. It was in recognition of this need that Alida was born.

Although Alida bears a passing resemblance to the WATCH Surround Speaker, it is, not so much an upgrade, but a thoroughly re-imagined product. The Alida was designed primarily to function as a high quality wall-mounted loudspeaker for music reproduction, while still maintaining its ability to excel in multi-channel surround installations.





## The Primary Impediment to the Performance

Walls and ceilings wreak havoc on frequency linearity and dispersion due to their proximity to the transducer. And because most walls are drywall over studs, energy transferred to the wall from the loudspeaker can create unwanted resonance and ringing.

Alida overcomes these challenges in a variety of ways. First, the crossover design benefits from everything learned in the creation of the Duette, Wilson's loudspeaker designed to be used against walls and other boundaries. Second, the wall mount itself, machined from X-Material, isolates the speaker from the wall, effectively damping resonance from the mounting surface.

Finally, the new mounting system, re-engineered for Alida from aircraft grade aluminum, provides 30 degrees of rotation so the speaker can be more perfectly aligned in both the time domain and for the dispersion pattern to the listening position.

Alida's cabinet is constructed from the same proprietary materials found in products like Chronosonic XVX and Sasha DAW. The enclosure design was refined using Wilson's laser vibrometry analysis, which further reduced internal resonant artifacts to near zero.

In addition, a rear-wave diffuser, similar to the technology found in Wilson's larger speakers, helps reduce time-domain distortion inside the cabinet.



New cinematic experiences await those who choose the Dolby® systems. Alida is ready. Surround Sound has come a long way from the original 3.1 systems. Dolby Atmos™ systems allows for configurations like 7.1.4 or 9.1.2 (the last number refers to the number of ceiling mounted speakers).

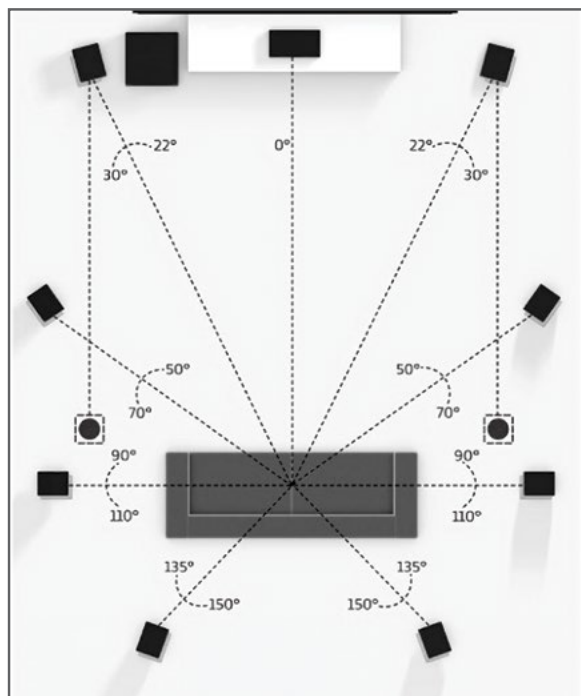

Because Alida remains the uncompromising choice for state-of-the-art cinema surround, we naturally had to stay current with the newest technology, and so we developed the Alida Ceiling Mount.







## Specifications

**Enclosure Type Mid-Woofer:** Front Ported

**Mid-Woofer:** One—5 3/4 inches (14.61 cm)

**Tweeter:** One—1 inch (2.54 cm)

**Sensitivity:** 84 dB @ 1 Watt @ 1 Meter @ 1 kHz

**Nominal Impedance:** 4 ohms / minimum 5.35 ohms @ 268 Hz

**Minimum Amplifier Power:** 50 Watts per channel

**Frequency Response:** 32 Hz – 27 kHz +/- 3dB Room Average Response [RAR]

**Overall Dimensions:** Height—25 inches (63.50 cm)

Width—11 3/8 inches (28.89 cm)

Depth—2 13/16 inches (32.50 cm)

**System Weight Per Channel (uncrated):** 58 lbs each (26.31 kg) w/mount

**Total System Shipping Weight (approx.):** 220 lbs (99.79kg)





# PEDESTAL<sup>®</sup>

*“As I wrap up this review, I have 14 Wilson Pedestals in use in my system. I don’t plan on removing any of them. I purchased all of the review samples that Wilson provided me.”*

*Mohammed Samji, Part-Time Audiophile*

AUTHENTIC EXCELLENCE



## The Industry Leader in Composite Research

Wilson's experience in and commitment to the science and technology of resonance control is unsurpassed within the audio industry. Before most loudspeaker engineers had even considered the harmful effects of deficient cabinet materials on a transducer's ability to accurately pass an incoming signal, Dave Wilson was actively exploring esoteric composite cabinet strategies.

That was almost 50 years ago. In the intervening five decades, Wilson Audio has continued its inexhaustible search for the best nonresonant composites for specific applications. In their ongoing pursuit of greater fidelity, Wilson has also delved into the art and science of combining specific composites in strategic geometries. No other audio company has invested a greater percentage of its capital resources into the research and development of materials and composites than Wilson Audio. Its design team, armed with state-of-the-art testing tools, has explored, discovered, and developed more groundbreaking composites than any other audio company.

Wilson's latest and most advanced materials, "W" and "V", made their debut into the limited production WAMM Master Chronosonic (W-Material) and, most recently, Wilson's flagship loudspeaker, the Chronosonic XXV (V-Material). At the other end of the spectrum, Wilson's Special Applications Engineering Division engineered the groundbreaking ISOBase, a unique isolation platform for the TuneTot. The ISOBase allowed the TuneTot to be placed on bookshelves and desktops with heretofore unachievable isolation from those resonant surface

The design and engineering team's research surrounding the ISOBase led to a realization: the fundamental tenets that made the ISOBase so capable could form the basis for a state-of-the-art isolation device for general use. Thus, a multi-year-long research and development project commenced. The outgrowth of which was the Pedestal—Wilson Audio Special Applications Engineering's solution for near absolute vibration isolation.



## Important Details

- Each Pedestal is rated for weights up to 25lb/11.34Kg. A set of three successfully supports 75lbs. Add more Pedestals to accommodate greater weights.
- The color ring (varies depending on weight rating) indicates when the max weight rating has been reached. When the color is no longer visible, the Pedestal has reached its maximum load.
- Shipped in quantities of up to 3 units per box.
- Designed for use under electronics, digital transports, power supplies, tape machines, and turntables to acoustically isolate these components from the environment as well as to substantially reduce vibrations traveling from components to the surface below.
- NOT intended for use under loudspeakers.
- WASAE's patented design provides an unprecedented degree of decoupling between outer housing and constrained damping layers.
- Designed and manufactured alongside Wilson Audio loudspeakers in the USA



## The Results

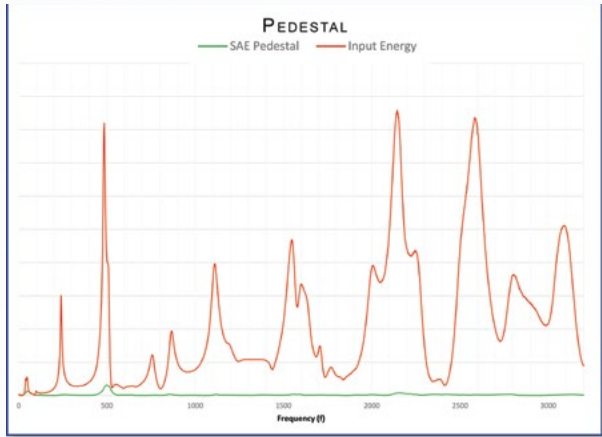

One of the questions the engineers asked while developing the Pedestal: How well does the isolation device under test reduce unwanted broadband energy from entering an audio component? In order to measure their progress accurately, the design team employed an innovative tool, Wilson's Modal Exciter, which introduces broadband vibrations into a structure in a precisely controlled and repeatable way.

The engineers placed the isolation product under test on Wilson's Modal Exciter, positioned in such a way that duplicated real-world applications. The team then placed a substrate, with the dimensions and weight of a typical audio component, on top of the set of the isolation products under test. Using Wilson's 3-Dimensional Accelerometer, another of the team's sophisticated research tools, the engineers measured the remaining energy in the substrate.

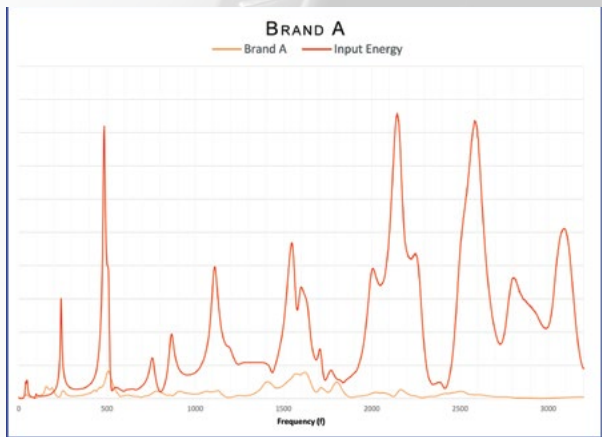
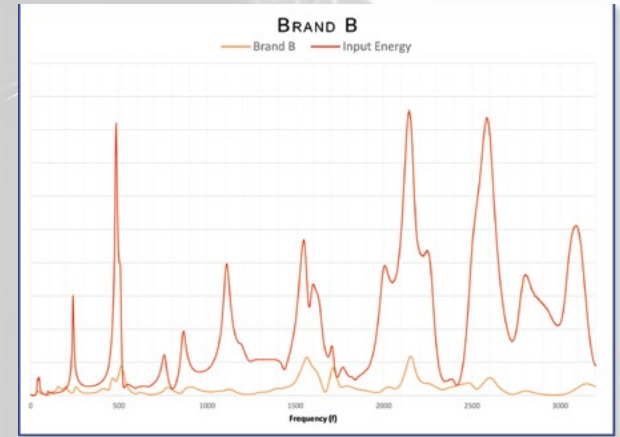

Wilson's engineers utilized this experimental procedure to chart the engineers' progress during the development of the Pedestal. Using the same method, they conducted further comparisons between the Pedestal and several competing devices.

The charts to the left and right illustrate a sampling of the results of our testing. The red line represents the original energy. The line beneath is the energy that remains in the component placed upon the set of devices. The devices were sample isolation products from prevalent manufacturers in this product segment and ranged in price from \$500 to \$2,700 a set.

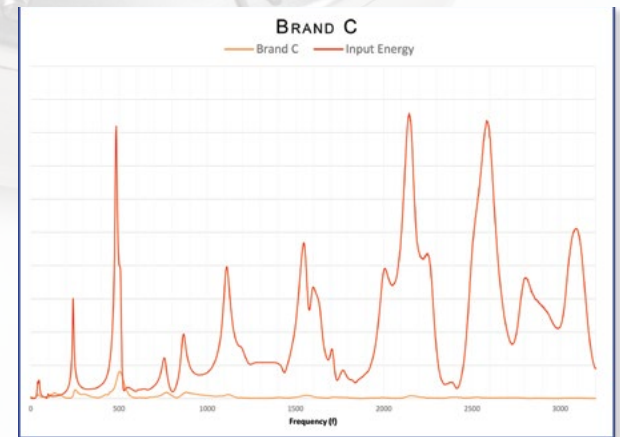

The Pedestal's chart is on the upper left.



# Pedestal Specifications

## Light

Amplifiers, Electronics, Turntable,  
Power Conditioner, etc

### Materials

V-Material, Austenitic Stainless-Steel,  
Damping Materials

### Dimensions

1 5/16" H x 2 1/4" W

### Weight Per Unit

8 oz (0.24 kg)

### Weight Rating Per Unit [Min - Max]

3 - 9 lb (1.36 - 4.08 kg)

3 Per Box

## Standard

Amplifiers, Electronics, Turntable,  
Power Conditioner, etc

### Materials

V-Material, Austenitic Stainless-Steel,  
Damping Materials

### Dimensions

1 5/16" H x 2 1/4" W

### Weight Per Unit

8 oz (0.24 kg)

### Weight Rating Per Unit [Min - Max]

8 - 25 lb (3.63 - 11.34 kg)

3 Per Box

## Heavy

Amplifiers, Electronics, Turntable,  
Power Conditioner, etc

### Materials

V-Material, Austenitic Stainless-Steel,  
Damping Materials

### Dimensions

1 5/16" H x 2 1/4" W

### Weight Per Unit

8.8 oz (0.25 kg)

### Weight Rating Per Unit [Min - Max]

10 - 52 lb (4.54 - 23.59 kg)

3 Per Box

## Wilson Audio Acoustic Diode Specs

### Materials

Proprietary "V-Material" & Austenitic Stainless Steel

### Dimensions

Height = 2 1/32" – 2 17/32" (5.16 cm - 6.43 cm)

Diameter = 2 5/16" (5.87 cm)

### Weight Per Unit

12 oz (0.34 kg)

8 Units / Box

### Available Thread Sizes

#### Standard

1/2"-13

#### Additional Sizes Available Upon Request:

3/8"-16

5/16"-18

1/4"-20

M6

M8

M10

M12

M14

#### Available Color Options:

Natural Stainless Steel

Carbon Black

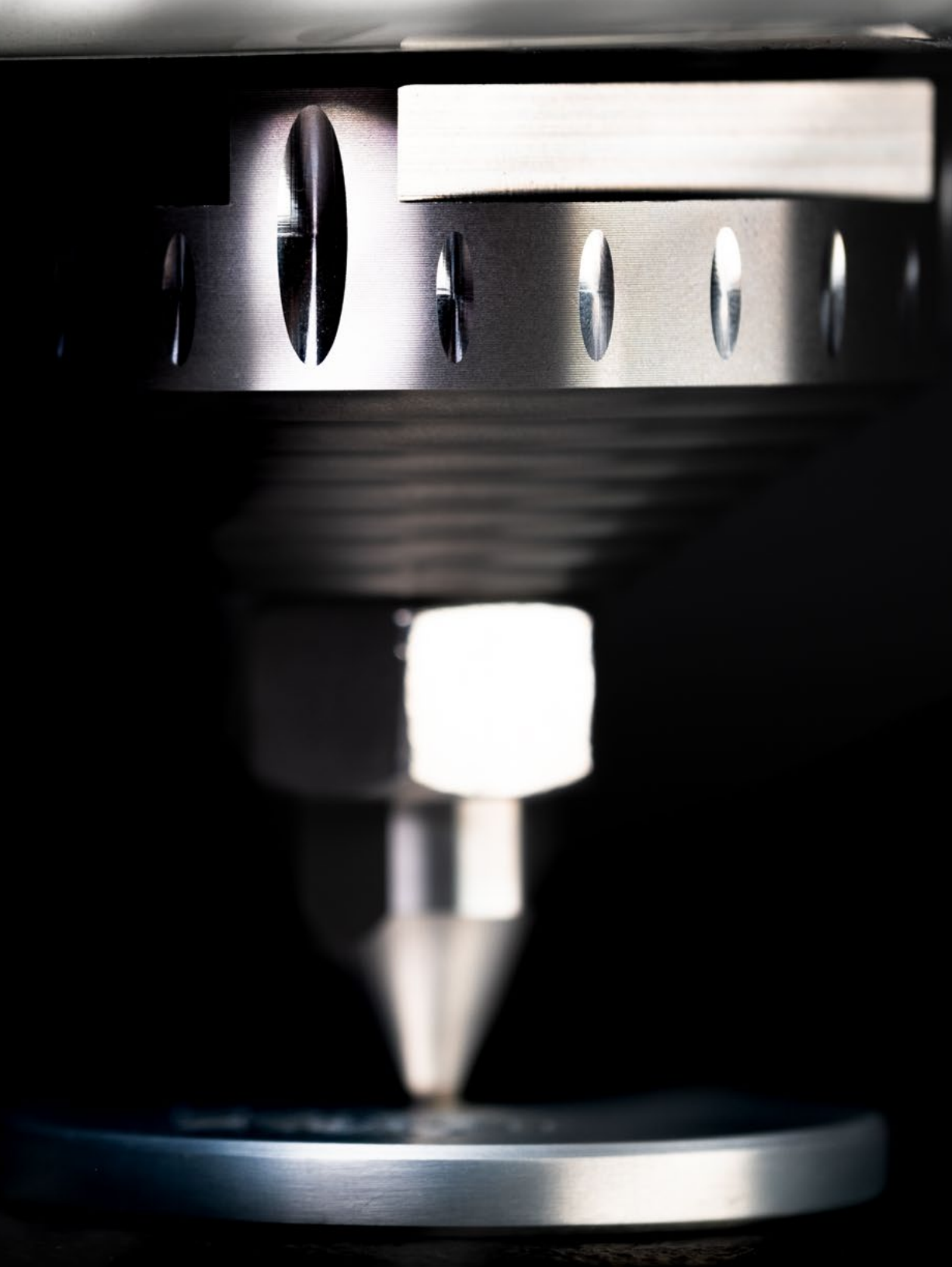

---

---

# WILSON AUDIO<sup>®</sup> ACOUSTIC DIODE

---

---

Building upon the research and development of Pedestal, the Special Applications Engineering Team is excited to announce the Wilson Audio Acoustic Diode. At the heart of the Acoustic Diode is our proprietary V-Material. This superior constrained layer damping composite is unsurpassed in vibration absorption and resonance control.

Energy from the enclosure migrates into the V-Material where it is faced with the effective damping properties of this efficient material. The mass of the loudspeaker concentrated onto the very small ends of the spike tips results in significant levels of PSI that prevent detrimental vibrations from traveling upward into the footer. Those vibrations that do travel up the spike are absorbed by the mass of the Acoustic Diode and have to travel through the V-Material to have a chance to influence the enclosure.

Keeping the spike and threaded post separate prevent a direct path for vibrations to travel, or interplay, and are therefore dissipated and absorbed in either the V-Material or the footer housing. This distinctive design, combined with advanced vibration-mitigating materials, provides the best of both worlds; a solid base from which the drivers can launch as well as preventing the transmission of energy from the floor to the loudspeakers.

AUTHENTIC EXCELLENCE

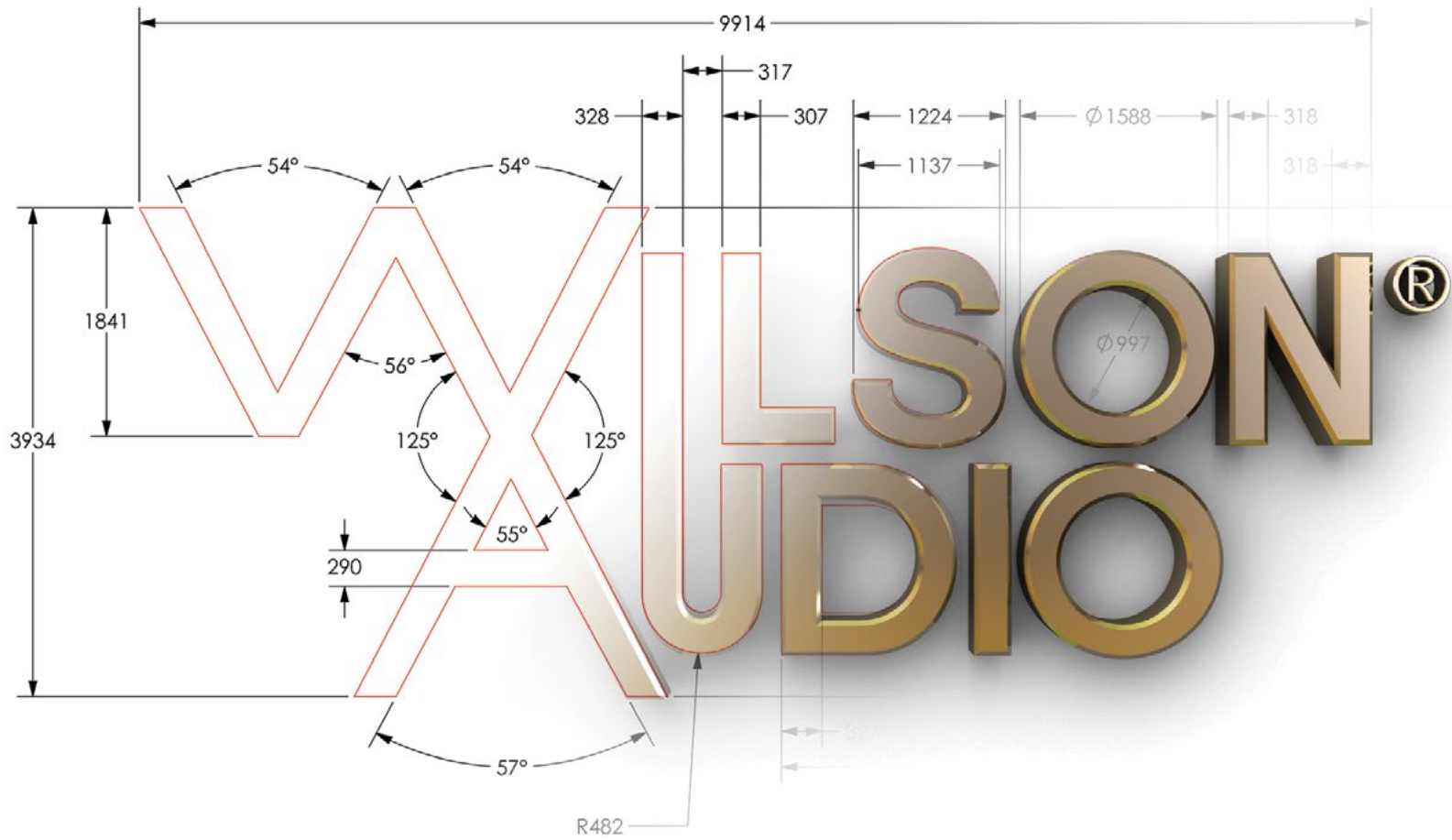



# WATCH<sup>®</sup>

Wilson Audio Theater Comes Home

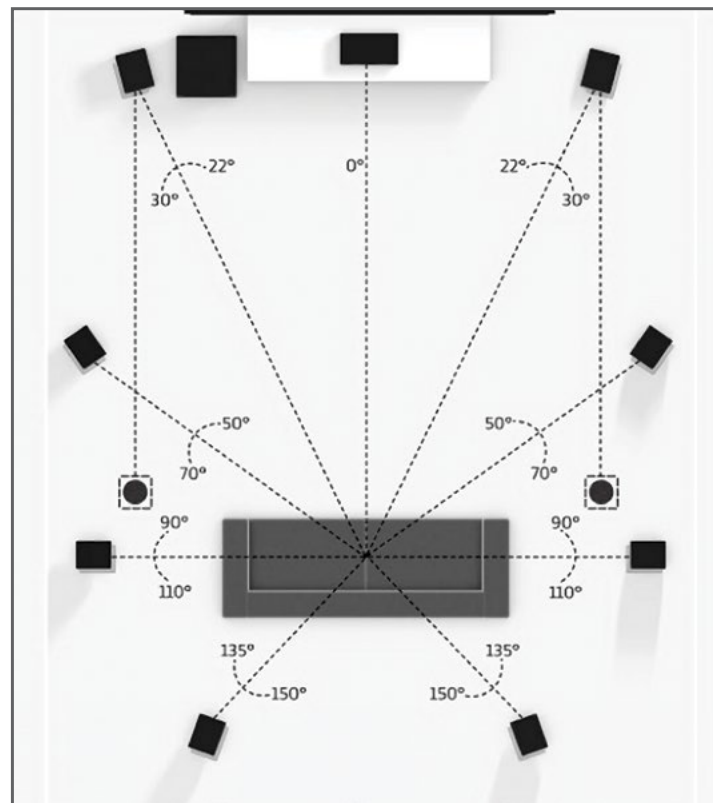

AUTHENTIC EXCELLENCE



## A Totally Involving Theater Experience

For most people, the intuitive starting point would be picture size and video quality. The rapidly evolving technologies of home video reproduction offer today's home theater owner a degree of visual realism unattainable even a few years ago.

Unfortunately, the human penchant for the visual (when was the last time anyone asked you: "Heard any good movies lately?") perpetuates system choices that are biased toward video. It's all too common for the audio portion of the typical home theater to come up short.

Some interesting trials validate a counter-intuitive thesis: When viewers were asked to rate the impact of two different home theater systems—one with a larger, better quality screen, but with a middling sound system, and the second with a smaller screen but a state-of-the-art audio system—they invariably chose the system with better sound as the more emotionally involving.

The WATCH system (Wilson Audio Theater Comes Home) was born out of this recognition. Bringing home the emotional impact of live music through two-channel reproduction has been the organizing passion of Wilson Audio since its inception in 1974. Applying the same focus and expertise to multi-channel theater systems was simply the natural extension of that passion.

With this generation of WATCH components, watching movies at home will never be the same.







## WATCH CENTER Convergent Synergy

The real magic of any loudspeaker happens in the midrange. Utilizing two of the legendary Wilson mid-range drivers from WAMM Master Chronosonic, the third generation Wilson Center Channel offers levels of midrange dynamic speed and alacrity that are hallmarks of Wilson's floor-standing loudspeakers.

Wilson center-channel loudspeakers have always been modular and adjustable in the time domain. The adjustable tweeter module facilitates precise time alignment between the center channel and the front stereo speakers, creating a completely coherent and three-dimensional sound field. Now, as a result of enhancements to the tweeter module mounting hardware, these adjustments are achieved with greater precision and ease.

The WATCH Convergent Synergy's front baffle is angled upward, directing the sound more correctly at the listener's ears, especially important when the Center is mounted low, beneath a screen. The WATCH Convergent Synergy utilizes X-Material in both tweeter and woofer enclosures. S-Material, Wilson's composite first used in the Sasha, now finds its place in the WATCH Convergent Synergy's mid-woofer baffle. The new cabinet minimizes enclosure resonances and enhances the Center's settling characteristics, allowing for better micro dynamics and deeper shades of black.





## Mezzo Convergent Synergy

Like all WATCH products, Mezzo was developed by the Wilson Special Applications Engineering team. Wilson has a long and storied history of developing products for specific applications. The first product to fit that definition was the Wilson Audio Tiny Tot, or WATT. Long before it became the mid and upper range part of the venerable WATT/Puppy combo (the best selling over \$10k loudspeaker in audio history), it was originally designed by Dave Wilson as a portable location monitor. The WATT played a significant role in the series of audiophile-quality records Dave engineered in the mid-70s to late-90s.

The Mezzo was also formulated and engineered with a specific function in mind: A loudspeaker endowed with a nearly identical sonic signature to Wilson's Sasha DAW, but in a low-profile form. When used as a center channel, Mezzo seamlessly matches the acoustic signature of Wilson's remarkable Sasha. Indeed, the Mezzo features a driver complement nearly identical to the Sasha's. Whether it is used as a center channel in conjunction with Sasha, Alexia, or Alexx, Mezzo matches the tonal beauty, dynamic speed, tonal sophistication, resolution, and sense of "thereness" that are hallmarks of Sasha DAW.





An adjustable tweeter module design allows for optimization of Mezzo's geometry specifically addressing the challenges of a low-profile loudspeaker. Achieving near perfect driver-alignment at the listening position requires the adjustment of the tweeter by changing its relative position in relation to the midrange and woofer drivers, such that all of the drivers' acoustic centers are equidistant from the listener. The tweeter module is adjustable via a provided chart according to ear height and listening distance—and for a variety of Mezzo installation strategies. Whether the Mezzo Convergent Synergy is installed directly on the floor, on one-of-two custom designed stands, or in custom cabinets, the Mezzo's drivers can be properly aligned to accommodate each of these scenarios.

The Mezzo crossover features technology adapted from the Sasha W/P Series 2. The goal was to reduce propagation-delay “jitter”—noise generated as a result of interactions between the different crossovers. As a result, Mezzo's overall resolution, inter-transient silence, dynamic speed and nuance are nearly identical to the Sasha.

S-material is Wilson's enclosure composite designed in conjunction with the Sasha W/P. The Mezzo's S-Material front midrange baffle reduces measurable and audible noise and coloration in the critical midband. Wilson's proprietary X-Material is used in the balance of the enclosure walls, continuing Wilson's practice of building ultra-low resonance cabinets.

The Mezzo is available with two stands. The Hourglass Stand features a solid front plinth, which allows for  $2\pi$  Steradian support of the midrange and woofer drivers, resulting in more linear and impactful performance in the upper bass and lower midrange. The second optional stand features a pedestal that can be customized for different heights.

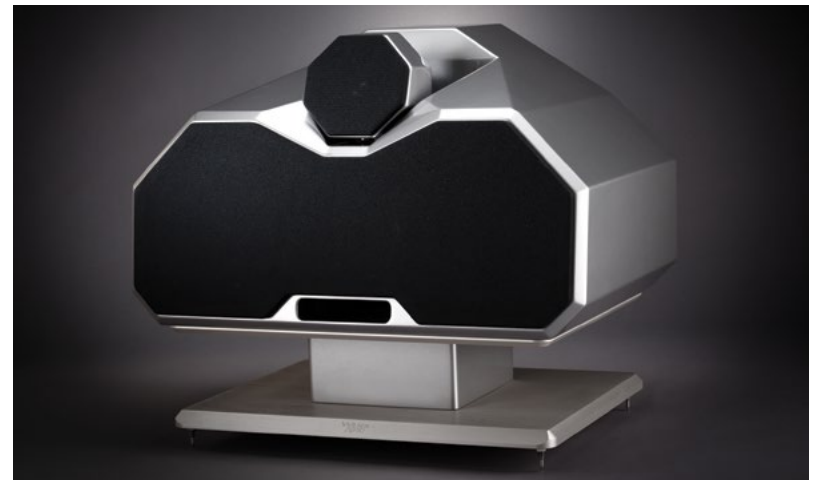

## WATCH Center Specifications

**Mid-Woofers:** Two—7 inches (17.78 cm)

**Tweeter:** One—1 inch (2.54 cm)

**Sensitivity:** 95 dB @ 1 Watt @ 1 Meter @ 1 kHz

**Nominal Impedance:** 4 ohms / minimum 2.4 ohms @ 610 Hz

**Minimum Amplifier Power:** 50 Watts

**Frequency Response:** 40 Hz – 25 kHz +/- 3dB Room Average Response [RAR]

**Overall Dimensions:** Height—13 13/16 inches (35.16 cm) w/o spikes

Width—20 inches (50.8 cm)

Depth—18 7/16 inches (46.90 cm)

**Stand Height: (without spikes):** 14 inches (35.56 cm)

**System Weight Per Channel (uncrated):** 77 lbs each (34.93 kg) w/o Stand

**Center Stand Weight (uncrated):** 48 lbs each (21.77 kg)

**Total System Shipping Weight (approx.):** 124 lbs each (56.25 kg) Center 3  
55 lbs each (24.95 kg) Stand

## Mezzo Specifications

**Woofers:** Two—8 inches (20.32 cm)

**Midrange:** One—7 inches (17.78 cm)

**Tweeter:** One—1 inch (2.54 cm)

**Sensitivity:** 96 dB @ 1 Watt @ 1 Meter @ 1 kHz

**Nominal Impedance:** 4 ohms / minimum 2.8 ohms @ 98 Hz

**Minimum Amplifier Power:** 25 Watts

**Frequency Response:** 20 Hz – 22.5 kHz +/- 3 dB Room Average Response [RAR]

**Overall Dimensions:** Height—17 3/8 inches (44.13 cm) w/o spikes

Width—29 1/2 inches (74.93 cm)

Depth—20 7/8 inches (53.06 cm)

**System Weight Per Channel (uncrated):** 159 lbs each (71.21 kg) w/o Stand

**Total System Shipping Weight (approx.):** 250 lbs each (113.40 kg) w/o Stand





# Subwoofers

AUTHENTIC EXCELLENCE





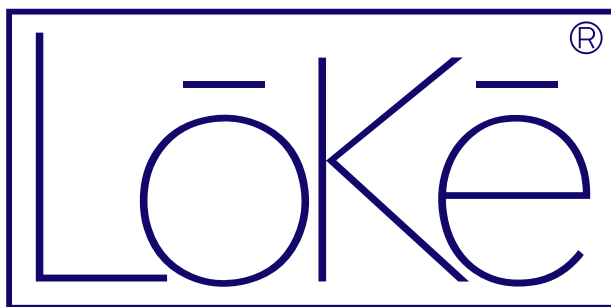

*"I wasn't sure what to expect when I added the LōKē into my system with Alexia 2 loudspeakers. I was simply astounded by the improvement which manifested in both additional visceral impact and a more precise rendering of instruments on the soundstage. Once you've heard it, there is no going back."*

Lee Scoggins, *The Absolute Sound*

AUTHENTIC EXCELLENCE

## Wilson Audio's Smallest Subwoofer

At the heart of every Wilson Audio product, you will find designs specifically created to elevate the audio playback experience in your home.

This beautiful subwoofer is handcrafted by the same artisans and professionals who sculpt all Wilson Audio loudspeakers made in the United States of America.

LōKē is an all-in-one, simple to setup, and easy to manage subwoofer solution. Incorporated into LōKē's built-in amp are the most utilized functions from Wilson Audio's acclaimed ActivXO Dual Subwoofer Crossover, including such key parameters as crossover frequency, crossover slope, phase, and level.

LōKē encompasses full compatibility across the myriad of TuneTot installations but also fundamentally expands the core capabilities of our other smaller floorstanding loudspeaker models: SabrinaX, Yvette, Sasha DAW, and their predecessors.

From the beginning, the Wilson Audio Special Applications Engineering team wanted to create a subwoofer system that follows the North Star development parameters set forth by David Wilson. We are excited to demonstrate how much of David's original intent is captured by LōKē and invite you to visit your local authorized Wilson Audio Dealer for an unforgettable musical experience that will reshape your thinking around small footprint subwoofer systems.





## Specifications

**Enclosure Type:** Front Ported

**Woofers:** One—10 inches (25.4 cm)

**Amplifier Power:** 500 Watts

**Frequency Response (Amplifier):** 20 Hz – 250 Hz (+/- 1 dB)

**Effective Piston Area:** 21.75 in<sup>2</sup>

**Effective Displacement:** 33.42 in<sup>3</sup>

**Overall Dimensions:** Height — 20 3/4 inches (52.71 cm) w/spikes

Width — 13 7/8 inches (35.24 cm)

Depth (With Grille) — 21 3/4 inches (55.24 cm)

**System Weight Per Channel (uncrated):** 110 lbs each (49.9 kg)

**Total System Shipping Weight (approx.):** 175 lbs each (79.38 kg)





*"I started this review with a question: could the addition of two Wilson WATCH Dogs elevate my listening experience? After seven months of listening, I have no doubt that the addition of two Wilson WATCH Dogs can elevate the performance of two already world class loudspeakers. The improvements seem to come with no downside, no boom, no overhang, and no loss of speed. Instead, I experienced a little more hall ambiance and everything had more dimension, weight and just the right level of gravitas. I am not looking forward to packing up the WATCH Dogs and Wilson Audio ActivXO and returning the review samples. Highly recommended."*

**Mohammed Samji, Part-Time Audiophile**



## Deep Bass The Wilson Way

The WATCH Dog is an ultra-high-performance, compact, passive subwoofer. There's a widespread myth that since subwoofers operate in the low to subsonic frequency range, the sonic quality of the amplifier used to drive them is not critical. Couple that with the fact that FTC-mandated criteria for power amplifier specifications don't apply to active subwoofers—a loophole which allows manufacturers to wildly inflate performance claims for what are, in many cases (no pun intended) the severely sub-standard amplifiers built into their subwoofers.

When designing the WATCH Dog, special attention was paid to the driver itself. This proprietary twelve-inch woofer was specifically optimized for the two bottom octaves of the audible bandwidth. The driver features a dual spider design, triangulating its geometry (the third variable being the cone's surround) such that the high-excursion cone can only move pistonically. An often-ignored area addressed in the Dog subwoofer driver is reducing out-of-band distortions and colorations. The Dog simply does what it was designed to do: Extend the main speaker's range deep into the bottom two octaves without the deleterious colorations and transient distortion exhibited by almost all competing designs.

The new passive WATCH Dog is a relatively compact and flexible solution for state-of-the-art subwoofer performance, whether in a single unit or a multiple unit configuration. Key to this flexibility is the external WATCH Controller.

A true subwoofer, capable of clean, distortion-free sub-frequency response, has to be sufficiently large to move the volume of air which visceral frequencies require. As hard as some manufacturers may try, there's no getting around the laws of physics on this one. The key is proper internal volume. Since there are no electronics to house, the WATCH Dog remains small for its extreme performance, making placement in your listening environment easy with no sacrifice in performance.



## Specifications—WATCH Dog (Passive)

**Enclosure Type:** Front Ported

**Woofers:** One—12 inches, Dual Spider (30.48 cm)

**Sensitivity:** 83 dB @ 1 Watt @ 1Meter @ 100 Hz

**Nominal Impedance:** 8 ohms / minimum 5.6 ohms @ 1 kHz

**Minimum Amplifier Power:** 200 Watts (for theater applications)

**Frequency Response:** 15 Hz – 300 Hz Room Average Response [RAR]

**Overall Dimensions:** Height—26 7/8 inches (68.26 cm) w/spikes

Width—18 inches (45.72 cm)

Depth (With Grille)—25 1/8 inches (63.82 cm)

**System Weight Per Channel (uncrated):** 211 lbs each (95.71 kg)

**Total System Shipping Weight (approx.):** 281 lbs each (127.46 kg)



# THOR'S<sup>®</sup> HAMMER

*"The fit and finish of Wilson speakers are the best in the business. No speaker is more luxurious...It doesn't get any bigger, badder or more lust-worthy in the world of subwoofers than Wilson Audio's Thor's Hammer...If you don't have Thor's Hammer...you don't have real bass"*

Jerry Del Colliando, *HomeTheaterReview*

AUTHENTIC EXCELLENCE



## A Subwoofer for Music Lovers

Audiophiles have regarded subwoofers as anathema to perfectionist music systems. Sure, they provide one thing: deep bass. But they typically do so at the cost of degrading performance in a whole host of other areas. The—not unreasonable—argument holds that since very little musical information occupies the ultra-deep bass region, not much is compromised by reducing output in the bottom octave.

In reality, though, the ideal subwoofer can reproduce more than the lowest pipe organ note. There is a wealth of ambient music cues in the deep-bass region. The ideal subwoofer opens up the soundstage to an extraordinary degree.

The benchmark in designing Thor's Hammer was simple: Create a subwoofer that would be, in every measure, a worthy addition to a music system built around Wilson's flagship loudspeaker, the Chronosonic XVX or Alexx V—no easy task since both loudspeakers extend comfortably below 20 Hz.

That meant primarily two things: First, the subwoofer had to perform with the same alacrity and dynamic range as the XVX and Alexx V. Secondly, it was critical that the Hammer not create out-of-band distortions and colorations (both typify almost all consumer subs) that would rob the bigger Wilsons of their singular glory, which is, natural, revelatory, and seductive midrange.

It goes without saying, having built a subwoofer that integrates seamlessly with Chronosonic XVX (Thor extends a loudspeaker's bandwidth down to 10 Hz), in turn, we've created a subwoofer that will enhance systems built around Alexias, Sashas—or even, if you're into physical extremes, SabrinaX.



## The Norse God of Thunder

Thor is often depicted carrying a short-handled hammer named Mjollnir, a symbol of his awesome power. Thunder is a fitting symbol to associate with Wilson Audio's state-of-the-art subwoofer. Truth be told, our product might conceivably give Thor an inferiority complex. Thunder, you see, primarily occupies the frequency spectrum from 20-120 hertz. Thor's Hammer (the subwoofer) is capable of reproducing—at full volume—the lowest pipe organ note at 16 Hz.

Subwoofers are nowadays *de rigueur* in home theater systems, but their history at Wilson Audio long predates soundtrack audio. Dave Wilson's first commercial product, the multi-cabinet WAMM, represented his effort to build a loudspeaker truly capable of reproducing the full range of music, including the lowest organ notes. Dave understood from the beginning that—when it comes to reproducing the lowest frequencies with dynamic realism and without distortion—there is no substitute for moving large volumes of air. The seven-foot tall now retired XS, designed for the X-1 Grand SLAMM, carried this uncompromising approach forward.

The Thor's Hammer is the lineal descendant of all these subwoofers. The Thor's Hammer utilizes the driver and crossover technology first developed for the WATCH Dog. It equals and even surpasses the performance of the XS in a cabinet that won't overwhelm most rooms. The result is flat bass extension below the limit of human hearing—into the frequency range where the word "visceral" becomes literally descriptive.





## Revolutionary Dual-spider Drivers

“Dual-spider” might sound like something from a creature movie, but it describes the long-throw driver technology developed for the WATCH Dog and now employed in its larger sibling.

Long-throw woofers allow Thor’s Hammer to achieve its 10hz response in a relatively compact enclosure. However, the longer the cone excursion, the greater its tendency to generate vectors of movement beyond the piston-like single plane, which is the theoretical ideal. These extraneous cone vectors produce distortion.

The dual-spider driver, which was first developed in a 12.5” design for the WATCH Dog, solves the issue by restricting woofer excursions to a single plane of motion.

Thor’s Hammer uses two custom-designed 15” dual-spider drivers in a dual-ported cabinet. The resulting distortion measurements are of the order one associates more with the finest quality amplifiers rather than with loudspeakers!

The cabinet itself is constructed primarily from Wilson Audio’s proprietary X-Material, an extremely dense and hard composite that achieves the seemingly contradictory attributes of high rigidity and high damping. Reducing cabinet resonance to irrelevancy is the *sine qua non* of accurate and grain-free music reproduction.

Thor’s Hammer is finished in the exclusive 12 step WilsonGloss paint process that gives all our loudspeakers their distinctive automotive quality luster. Aside from the four standard colors available, you can choose from a wide palette of upgrade colors available at a slight surcharge, or, by providing the factory with the desired paint sample, from a nearly limitless palette of custom colors.

## Specifications

**Enclosure Type:** Front Dual Ported

**Woofers:** Two—15 inches, Dual Spider (38.10 cm)

**Sensitivity:** 93 dB (2.0 Volts @ 1 Meter)

**Nominal Impedance:** 4 ohms

**Frequency Response:** 10 Hz – 150 Hz Room Average Response [RAR]

**Overall Dimensions:** Height—59 inches (149.86 cm) w/o spike

Width—20 inches (50.80 cm)

Depth (With Grilles)—25 13/16 inches (65.49 cm)

**System Weight Per Channel (uncrated):** 411 lbs each (186.43 kg)

**Total System Shipping Weight (approx.):** 545 lbs each (247.21 kg)





# WILSON AUDIO SUBSONIC<sup>®</sup>

*“The Subsonics added a new dimension of majestic sweep to this recording. The Subsonics also expanded the space and air of the Myerson Symphony Center by resolving very low-level, low-frequency components that cue the brain to the size of the hall. I also heard a greater midrange clarity on the voices with the Subsonics engaged, with more separation between the choir and the orchestra. Pipe organ spectaculars were just that—spectacular. The sense of limitless extension, limitless power, and limitless control, along with the precise sense of pitch with no port artifacts or bloat, was simply stunning. It’s really something you have to experience for yourself. I’ve never heard better bass from an audio system, or bass that extended this low and maintained its quality in the bottom two octaves.”*

**Robert Harley, *The Absolute Sound***



## Wilson Audio Subsonic

The Wilson Audio Subsonic is the fraternal twin of the WAMM Master Subsonic. It features the same subwoofer drivers and the same internal volume. The differences lie in the finish details. The metal work in the WAMM Master Subsonic features the prismatic finish that mirrors (no pun intended) the WAMM's main array gantry. On the Wilson Audio Subsonic, the metal work is from Wilson's main line finish process—the same level of metal finish that has adorned Wilson products throughout the line.

The internal bracing material within the Wilson Audio Subsonic is Wilson's proprietary HDF, the same bracing material that is found in the Thor's Hammer.

The Wilson Audio Subsonic bridges the gap between the Thor's Hammer, a subwoofer that before the WAMM Master Subsonic had no rival in the industry, and the WAMM Master Subsonic.

The Subsonic is the perfect addition to Alexx V or Chronosonic XVX, either configured as a single mono unit, or as a two-channel stereo pair. In either configuration, it offers performance in the 10-30hz range that is only exceeded by the WAMM Master Subsonic itself.

## Specifications

**Enclosure Type:** Front Dual Ported

**Woofers:** Three—12 inches, Dual Spider (30.48 cm)

**Sensitivity:** 87 dB (2.83 Volts @ 1 Meter)

**Frequency Response:** 10 Hz – 150 Hz Room Average Response [RAR]

**Nominal Impedance:** 4 ohms

**Overall Dimensions:** Height—65 1/16 inches (165.25 cm) w/o spikes

Width—18 1/16 inches (45.87 cm)

Depth—27 3/16 inches (69.06 cm)

**System Weight Per Channel (uncrated):** 505 lbs each (229.06 Kg)

**Total System Shipping Weight (approx.):** 685 lbs each (310.71 Kg)





WAMMIM<sup>®</sup>

*Master*

SUBSONIC

AUTHENTIC EXCELLENCE



## WAMM Master Subsonic

From its inception, the WAMM Master Chronosonic was designed to cover the entire audible spectral bandwidth with an unprecedented time-domain fidelity, ultra-low distortion, and exceptionally well controlled enclosure resonance. It is a laboratory grade instrument on the one hand and an unalloyed conduit to a numinous connection to music on the other.

The Master Chronosonic is a full range loudspeaker, capable of reproducing the bottom octaves of music with extreme speed and authority, but Wilson's design team also recognizes the advantages presented by fully active bass management and a dedicated subwoofer.

While most manufacturers of subwoofers attempt to bend the immutable laws of physics with undersized enclosures and drivers, Wilson's approach to the bottom octave is uncompromising and pure. The WATCH Dog and the state-of-the-art Thor's Hammer are designed to reproduce the region between 10 and 40hz without the aid of distortion-producing equalization or other Band-Aids to poor or compromised designs.

The WAMM Master Subsonic subwoofer builds on the strengths of the Thor's Hammer. The Subsonic employs three dual-spider woofers in an enclosure tuned to reproduce the infra-sonic range below 10 Hz, and, at the same time, seamlessly and coherently mesh with the Master Chronosonic in the lower midbass region. Extreme transient speed is not a intuitive characteristic associated with subs; the Subsonic was designed to cover the bottom octaves at the same level of transient fidelity that characterizes the WAMM Master Chronosonic.

*\*This version is only available with the WAMM Master Chronosonic.*

## Specifications

**Enclosure Type:** Front Dual Ported

**Woofers:** Three—12 inches, Dual Spider (30.48 cm)

**Sensitivity:** 87 dB (2.83 Volts @ 1 Meter)

**Frequency Response:** 10 Hz – 150 Hz Room Average Response [RAR]

**Nominal Impedance:** 4 ohms

**Overall Dimensions:** Height—65 1/16 inches (165.25 cm) w/o spikes

Width—18 1/16 inches (45.87 cm)

Depth—27 3/16 inches (69.06 cm)

**System Weight Per Channel (uncrated):** 515 lbs each (233.60 kg)

**Total System Shipping Weight (approx.):** 695 lbs each (315.25 kg)

## ActivXO

The ActivXO is the long-awaited and thoroughly updated replacement for Wilson's revolutionary Controller. It is a two-channel, fully analogue electronic crossover with an array of features. It can be used in conjunction with a dedicated music system, or as the subwoofer control unit in a home theater system. In systems used for enjoyment of music and surround film, the ActivXO is configurable to accommodate both—optimally and simultaneously.

For those systems where the ActivXO is used in a hybrid music and home theater system, then the ActivXO becomes the brains behind that flexibility, whether you're using one subwoofer or several. In movie mode, the low frequency effects output from your processor goes directly through the ActivXO to the Wilson Subwoofers' amplifier.

When music is the primary focus, with a simple flick of a switch (accomplished either with a front panel toggle or a 12 volt trigger) the ActivXO becomes a feature-rich active crossover. You can control both crossover frequency and slope for the high-and low-pass filters. A continuously variable phase control ensures any Wilson loudspeaker seamlessly integrates with any of Wilson's subwoofers.

The ActivXO accepts both single-ended and balanced inputs, and can output to one or a stereo pair of subwoofers for the most demanding applications. It can be used with any of Wilson's subwoofers, and is included with the purchase of the WAMM Master Chronosonic.







## Specifications

**Input Impedance:** 56k ohms Single-Ended, 4k ohms Bal.

**Inputs:** Balanced and Single-Ended

**Outputs:** Processor High-Pass, Balanced and Single-Ended,  
2 Stereo Low-Pass, Balanced and Single-Ended,  
2 Mono Level & Frequency (30 to 150 Hz)

**Low Pass Filter:** Adjustable, 12 dB or 18 dB/Octave  
Level & Frequency (30 to 150 Hz)

**High Pass Filter:** Adjustable, 6 dB or 12 dB/Octave

**Phase:** 0 - 180 degrees, Continuously Variable

**EQ:** Variable Frequency (30 to 150 Hz)  
Level (+/- 10 dB), and Q (.2 to 2)

**Dimensions:** Height: 4 1/2 inches (11.43 cm) - Includes feet  
Width: 19 inches (48.26 cm)  
Depth: 11 1/2 inches (29.21 cm) - Includes knobs

**Weight:** 16.75 lbs (7.6 kg)

**Total Shipping Weight (approx.):** 18.95 lbs. (8.6 kg)



X-1 Grand SLAMM, circa 1999



MAXX Series 2, circa 2004



Sophia Series 2, circa 2001



WATT/Puppy System 6, circa 1998



AUTHENTIC EXCELLENCE



## Generations of Audiophiles and Music Lovers

Wilson Audio's commitment to those who make an investment in our products extends well beyond the warranty period, and even beyond the original owner. From the beginning, it was Dave's vision that there would not be a "best by" date that would end his commitment to the products his company built. Motivated by this ideal, he set out to build the best customer service department in the industry, a key part of which is a stocking program that includes all the parts necessary to service any Wilson loudspeaker, regardless of vintage.

Wilson loudspeakers are enjoyed over time by generations of music lovers and enthusiasts. Certified Authentic guarantees to the purchaser of a previously owned Wilson Loudspeaker that the performance will be the same as when it was first sold as new.

See your Wilson Dealer for further information and details, as well as current available stock.

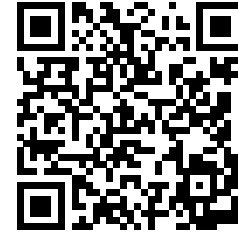

Wilson Audio Certified  
Authentic Program







WATT on Gibraltar Stand, *circa 1986*







- Replacement Resistors
- Books and Literature
- Wilson Audio Brand Loudspeaker Covers
- Installation Tools and Accessories
- Additional Grilles and Diffraction Blankets
- WilsonGloss Care Products and Kits
- Wilson Audio Signature Apparel
- . . . And More



Wilson Audio Store



Ruby Red Pearl

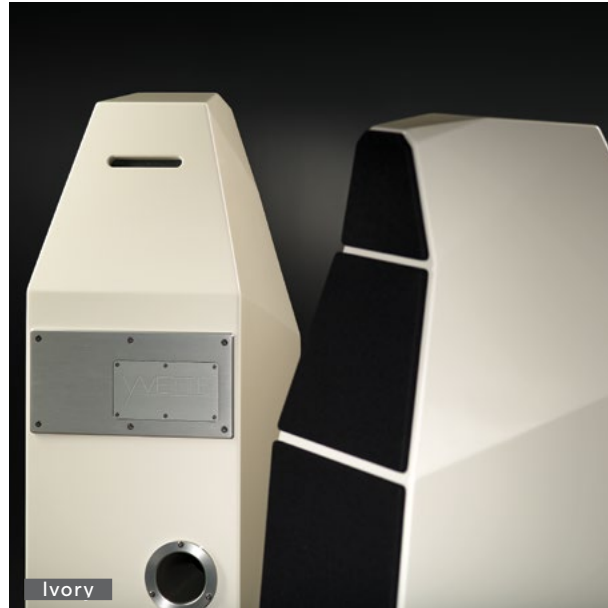

Ivory



Galaxy Gray



Saffron Pearl

## WilsonGloss Colors

Wilson Audio's commitment to quality begins with the sound of our loudspeakers, but hardly ends there. The physical beauty and craftsmanship of Wilson products have long set the benchmark for the industry. Now, Wilson Audio is excited to introduce an updated and expanded range of colors, which include new Premium Pearl options.

WilsonGloss is a multi-stage process, from a proprietary protective gel coat layer through base color to the final series of clear coats—all followed by meticulous hand polishing. The final finish is unrivaled—even by the world's greatest automobile manufacturers. Wilson loudspeakers (with the exception of the SabrinaX and TuneTot—contact your Dealer for options) are available in a choice of five standard WilsonGloss colors. We have updated the selection of upgrade colors, which are available at a modest surcharge. Our Premium WilsonGloss includes five new colors, each in a special pearl finish, which involve additional paint steps. WilsonGloss Premium is the ultimate expression of sophistication and beauty.

When combined with a choice of six grille-cloth colors, it's easier than ever to individually design your Wilson loudspeaker so that it will complement your décor, or express your pride of ownership. Along with standard black grilles, you can alternatively specify Slate Grey, Parchment Grey, Mocha, Blanco White, or Le Mans Blue at no additional cost. With hundreds and hundreds of combinations available, you have the ability to design a Wilson speaker unique to your taste and décor.

For the ultimate in individual expression, Wilson Audio offers Custom Sample Match WilsonGloss finishes. Through your Wilson Dealer, provide us with your wall color, favorite automotive paint, or just about any color sample and we can, for an additional cost, create your loudspeakers in a one-of-a-kind WilsonGloss finish. This service includes on-site storage of custom paint for a period of five years. Contact your Dealer for program requirements and pricing.



### WilsonGloss Standard Colors

---



Galaxy  
Gray



Carbon



GT Silver

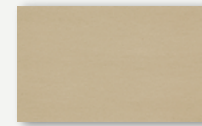

Quartz

### WilsonGloss Upgrade Colors

---

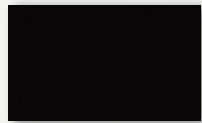

Diamond  
Black

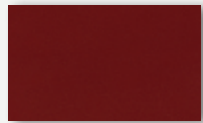

Crimson  
Satin



Fly Yellow

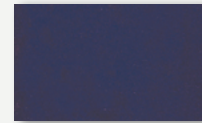

Estoril  
Blue



Nara  
Bronze



Pur Sang  
Rouge



Cobalt  
Blue Satin

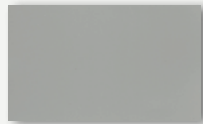

Chalk

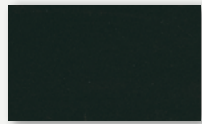

Obsidian  
Black

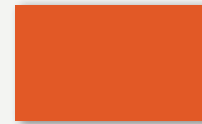

Classic  
Orange

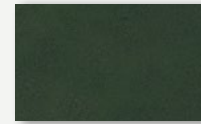

Oak  
Green Satin

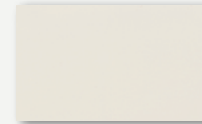

Ivory

### WilsonGloss Premium Pearl

---

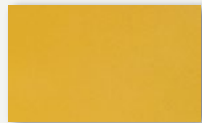

Saffron  
Pearl

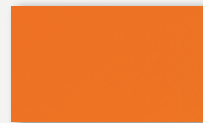

Bergamot  
Pearl

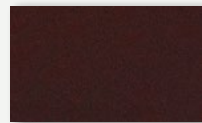

Cranberry  
Pearl

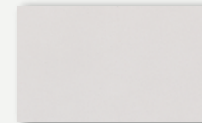

Olympia  
Pearl

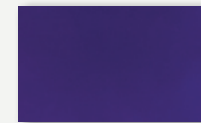

Viola  
Pearl

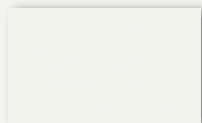

Glacier Frost  
Pearl

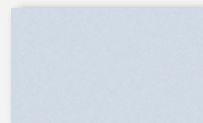

Silver Ice  
Pearl

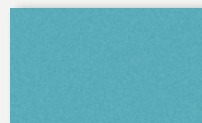

Blue Orchid  
Pearl



Ruby Red  
Pearl



Ember  
Pearl

### Wilson Grille Colors

---

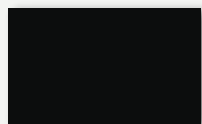

Black

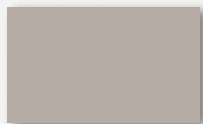

Parchment  
Gray

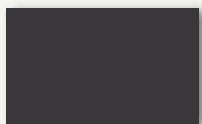

Slate Gray

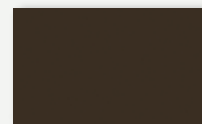

Mocha



Le Mans  
Blue

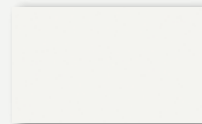

Blanco

Wilson Audio

2233 Mountain Vista Lane

Provo, Utah 84606

(801)377-2233 • [www.wilsonaudio.com](http://www.wilsonaudio.com)